

CABLE TIES & ACCESSORIES

EELEMATIC[®]
CABLING SYSTEMS



...max capacity!



Elematic Cabling Systems, with a production of cable ties all the year, 24 hours a day, 7 days a week is one of the worldwide top producers of polyamide cable ties.

A certified system (ISO 9001:2008), conformed to European Standards, guarantees the application of severe quality parameters on all stages, from the design to the production and after-sales service.

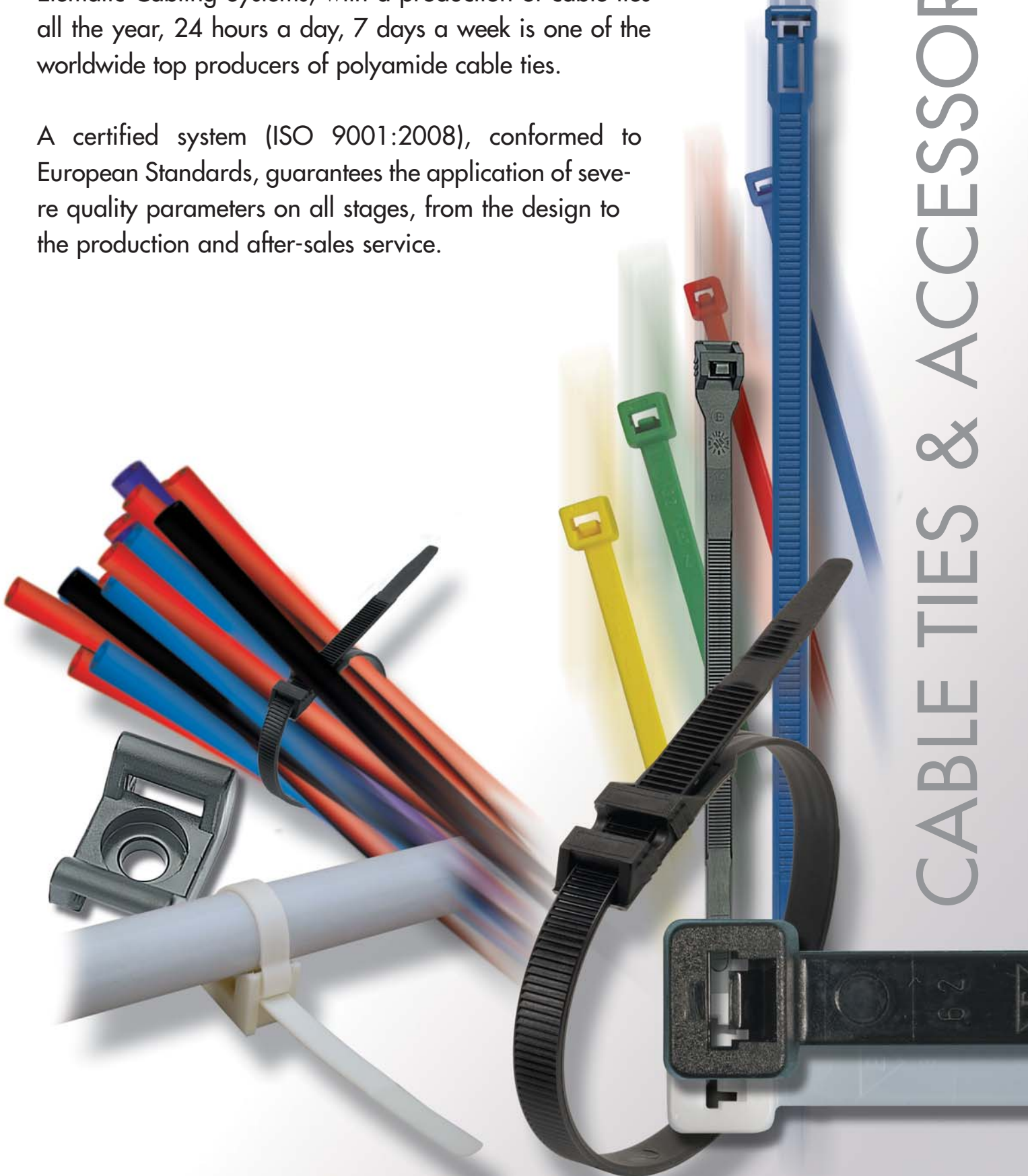

CABLE TIES & ACCESSORIES

How to choose the right cable tie

The most important characteristics of a cable tie are:

- the raw-material they are made of (weather, chemicals and heat resistance)
- the tensile strength they can stand (tear strength)
- the min and max diameter they can bundle
- the shape of the tie in case of particular applications
- the flammability rating

Hereby a few suggestions on how to choose the right cable tie for your application.

Resistance to chemical agents

Chemical agents as powders, liquids or gases can deteriorate the raw material cable tie are made of, or extract some components from the plastic compound. The mechanical properties of the cable tie can deteriorate as a consequence of the interaction with several compounds. In this case the performance of the product could not meet the required standards.

UV and weather resistant cable ties

All polymers including the polyamides used for the production of cable ties are sensitive to UV radiation.

The most common additive used for protecting polyamides from UV radiation is carbon powder commonly known as "carbon black".

Natural Cable Ties (Elematic codes 52xx) have low resistance to UV radiation and therefore are not suggested for outdoor applications.

Black Cable Ties (Elematic codes 53xx) are additivated with carbon black. They have improved weather and UV radiation resistance and are better suitable for outdoor applications, but this is not enough to protect the material from the damage due to the UV-radiation for a long time. For these needs the weather resistance cable ties could be used.

Tests performed in should labs give for black cable ties a resistance till 150 hours QUV-B radiation following ISO 4892 norm. This can be compared to ca. 3 years outdoor resistance on average exposure to South-European areas.

We underline that particular environmental situations as combination of exposure to chemical agents and UV radiation, exposure to very warm, humid and sunny weather, etc., can change dramatically the performance of the product. Our indications should therefore be used only as a reference. In case of specific needs, please contact our technical department.

Weather Resistant Cable Ties (Elematic codes 53xx UV) are made of a specially additivated compound to provide an extra weather resistance so that they are optional for outdoor applications.

Tests performed in recommended labs give for weather resistant cable ties a resistance till 600 hours of QUV-B radiation following ISO 4892 norm. This can be compared to ca. 10 years outdoor resistance on average exposure to South-European areas.



Heat resistance and self-extinguishing cable ties

All polymers including also polyamides used for the production of cable ties are sensitive to high temperatures.

Exposure to high temperatures can break the chemical bonds of the polymer causing degradation and loss of mechanical resistance. Polyamide products can therefore become fragile and sensitive to vibrations.

The max suggested installation temperature for standard cable ties is 60°C, while the max service temperature for continuous use is 85°C.

Heat Resistance Cable Ties (Elematic codes 53xx T) are made of a specially additivated compound to provide an extra heat resistance (max service temperature for continuous use up to 125°C).

Polymers are also sensitive to low temperatures. Application of polyamide 6.6 cable ties is possible till around -10°C. Standard polyamide becomes very brittle at temperatures below -40°C (min. suggested service temperature for continuous use).

Heavy-duty Cable Ties (Elematic "Belturing Plus" range) provide an extra resistance to cold temperature (installation possible till -30°C) and an excellent resistance to UV radiation, therefore they are suggested also for external applications and long term exposure under the sunlight and UV action.

Self-extinguishing cable ties (Elematic codes 52xx V0) are made of polyamide 6.6 with additives that gives the auto extinguishing performance; the halogen and phosphorus free material avoids toxic emission in event of fire and conforms to UL-94 V0 and GW 960 °C standards.

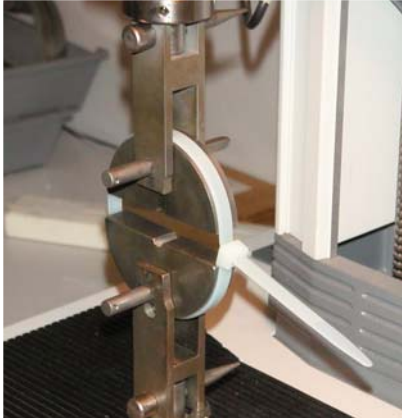

Tear resistance

The tear resistance is the most important parameter for choosing the right cable tie for a specific application.

The technical data sheets of Elematic cable ties give the minimum guaranteed tear resistance for all sizes.

Elematic cable ties are tested following the main international standards as EN 50146 and IEC 62275 using dedicated equipment and with a constant rate of 25 mm/min.

The strength causing the collapse of the cable tie is given in Newton (N).

The standard testing conditions are 23°C and 50% of relative humidity.

It is important to underline that the values arising from those laboratory tests may not be representative of the resistance to the loads of real installations, due to the presence of external factors (high humidity, vibrations, high temperatures, etc.).

We therefore suggest to apply a safety factor of at least 2. This safety factor should be chosen depending on the application conditions.

In case of severe working conditions, at high temperatures, high humidity, vibrations... this safety factor should be increased up to 5.

General indications for cable ties installation (2,2-4,8 mm)

Cable Ties width (mm)	2,2	2,5÷2,6	3,6	4,5÷4,8
Tool setting (daN)*	0<daN<3	3<daN<6	6<daN<10	10<daN<13

*1 daN = 1kg

For more details concerning specific requirements, please ask our technical department.

Flammability rating of Cable Ties

The UL 94 test (flammability of plastic materials for parts in devices and appliances) enables to compare plastic materials in terms of their burning behaviour. It gives indication either on the relative speed of burning, or on the ability to extinguish or not to propagate fire.

The classification starts with the lowest level HB till the highest V0 (best self-extinguishing value).

HB (Horizontal Burning) - Test description

Sample size	125 ± 5 x 13 ± 0.5 mm
Thickness	0.8; 1.6; 3.2; 6 mm Bar having marked lines at 25 and 100 mm from its end
Pre-treatment	48 hours / 23 ± 2 °C / 50 ± 5% RH
Burner	Bunsen Ø 9.5 mm 100 mm length
Flame height	20 ± 1 mm
Contact time	30 s

The material is classified HB if the burn rate measured between the 2 marks, does not exceed:
38.1 mm/min for 3.2 mm testbar thickness;
63.5 mm/min for <3.2 mm testbar thickness;
In both cases the testbar should stop burning before reaching the 100 mm mark.

VO-V1-V2 (Vertical Burning) - Test description

Sample size	125 ± 5 x 13 ± 0.5 mm
Thickness	0.8; 1.6; 3.2; 6 mm
Pre-treatment	One set of 5 testbar conditioned for 48 hours / 23 ± 2 °C / 50 ± 5% RH; One set of 5 testbar conditioned for 168 hours at 70 ± 1 °C
Burner	Bunsen Ø 9.5 mm 100 mm length
Flame height	20 ± 1 mm
Number of flame applications	2 x 10 s

A flame is applied 2 times on 5 testbars obtaining 10 values per set of testbars. Two sets of sample, differently conditioned are tested for a total of 20 values.

Classification	V0	V1	V2
Maximum burning time single specimen (s)	≤ 10	≤ 30	≤ 30
Maximum burning time total of 5 specimens (s)	≤ 50	≤ 250	≤ 250
Afterflame plus afterglow time for each individual specimen after the second flame application (s)	≤ 30	≤ 60	≤ 60
Afterflame or afterglow of any specimen up to the holding clamp	No	No	Yes
Cotton indicator ignited by flaming particles or drops	No	No	Yes

All standard Elematic polyamide 6.6 cable ties are made of UL 94-V2 classified raw material.
Coloured masterbatches are compliant to RoHS directive and are there fore prepared without Lead, Chrome or Cadmium, due to this reason colour can slightly change depending on moulding condition.

Special Cable Ties (Elematic codes 52xx V0 are made of a specially additivated compound to provide an extra self-extinguishing power (UL 94-V0).





Chemical Agent	Conc. %	Resist.
Acetaldehyde - aqueous solution	40	D
Acetamide - aqueous solution	50	G
Acetic acid - aqueous solution	10	P
Acetic acid - concentrated		P
Acetic anhydride - concentrated		S
Acetone	100	G
Acrylonitrile	100	G
Aluminium chloride - aqueous solution	10	G
Aluminium sulphate - aqueous solution	10	G
Ammonia	10	G
Ammonia - gaseous		L
Ammonium chloride - aqueous solution	10	G
Amyl acetate	100	G
Amyl alcohol	100	G
Aniline	100	D
Barium chloride - aqueous solution	10	G
Benzaldehyde	100	L
Benzoic acid - aqueous solution	saturated	D
Benzol	100	G
Benzyl alcohol	100	L
Bitumen		D
Boric acid - aqueous solution	10	D
Butane		G
Butyl acetate	100	G
Butyl alcohol	100	D
Butyric acid	100	D
Calcium chloride - aqueous solution	20	S
Calcium chloride - aqueous solution	10	G
Camphor	100	G
Chlorine - gaseous	100	P
Chlorine water		D
Chlorobenzene		G
Chlorobromomethane		D
Chloroform	100	P
Chromic acid - aqueous solution	10	P
Chromic acid - aqueous solution	1	D
Citric acid - aqueous solution	10	L
Cyclohexane	100	G
Cyclohexanol	100	G
Decaline		G
Diacetone alcohol		G
Ethyl acetate	100	G
Ethyl alcohol	96	D
Ethyl chloride	100	D
Butyl phthalate		G
Carbon sulphide	100	G
Carbon tetrachloride		G
Caustic potash - aqueous solution	5	G
Caustic potash - aqueous solution	50	D
Caustic potash - aqueous solution	10	G
Caustic soda - aqueous solution	5	G
Caustic soda - aqueous solution	50	D
Caustic soda - aqueous solution	10	G
Copper salts - aqueous solution	10	G
Copper sulphate - aqueous solution	10	G
Dichlorofluoroethylene		G
Diethanolamine		G
Dimethylformamide	100	G
Ethyl ether	100	G
Ethyl glycol		G
Formaldehyde - aqueous solution	30	G
Formamide		D
Heptane		G
Hexane		D
Hydrogen sulphide - aqueous solution saturated		P
Isooctane		G

G= Good resistance without noticeable variations in weight and/or volume
D= Discrete resistance with significant variations in weight and/or volume resulting from prolonged contact.

Chemical Agent	Conc. %	Resist.
Lead stearate	100	G
Magnesium hydroxide	10	G
Magnesium salts - aqueous solution	10	G
Mercury		G
Methylethylketon		G
Ferric Chloride - aqueous solution	10	G
Formic acid - aqueous solution	85	S
Formic acid - aqueous solution	10	P
Glycol butylene	100	D
Hydrochloric acid - aqueous solution	36	S
Hydrochloric acid - aqueous solution	10	P
Hydrochloric acid - aqueous solution	2	L
Hydrogen peroxide - aqueous solution	30	P
Hydrogen peroxide - aqueous solution	3	P
Hydrogen peroxide - aqueous solution	1	P
Hydrogen peroxide - aqueous solution	0,5	L
Isopropyl alcohol		D
Lactic Acid - aqueous solution	90	P
Lactic Acid - aqueous solution	10	D
Lead acetate - aqueous solution	10	D
Magnesium chloride - aqueous solution	10	G
Mercuric chloride - aqueous solution	6	P
Methyl acetate	100	G
Methyl alcohol	100	D
Methyl chloride	100	L
Nitric acid		P
Oleic acid	100	G
Oxalic acid - aqueous solution	10	D
Petrol		G
Phosphoric acid - aqueous solution	10	P
Phthalic acid - aqueous solution saturated		D
Potassium bichromate - aqueous solution	5	D
Potassium bromide - aqueous solution	10	D
Potassium carbonate	100	G
Propyl alcohol		D
Salicylic acid	100	G
Sodium bromide - aqueous solution	10	D
Sodium carbonate - aqueous solution	10	G
Sodium chloride - aqueous solution	10	G
Sodium disulphate - aqueous solution	10	G
Sulphuric acid - concentrated	98	S
Sulphuric acid - aqueous solution	10	P
Sulphuric acid - aqueous solution	2	L
Tartaric acid		D
Tartaric acid - aqueous solution	10	G
Thionyl chloride		P
Vinyl chloride	100	G
Water (sea, river, potable, distilled)		G
Zinc chloride	10	D
Methyl-isobutylketon		G
Mineral oil		G
Naphtha solvent		G
Nitrobenzol	100	D
Nitromethane	100	D
Octyl phthalate		G
Ozone		P
Perchloroethylene		P
Phenol - aqueous solution		S
Potassium nitrate - aqueous solution	10	G
Sodium hypochlorite - aqueous solution		G
Sodium nitrate - aqueous solution	5	P
Sodium nitrate - aqueous solution	10	G
Sodium phosphate - aqueous solution	10	G
Sodium sulphate - aqueous solution	10	G
Trichloroethylene		D
Zinc oxide		G

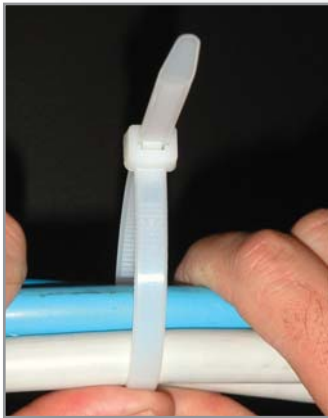
L= Limited resistance: It is possible to use the material in case of short contact.
P= Poor resistance; the material is strongly attacked.
S= Soluble

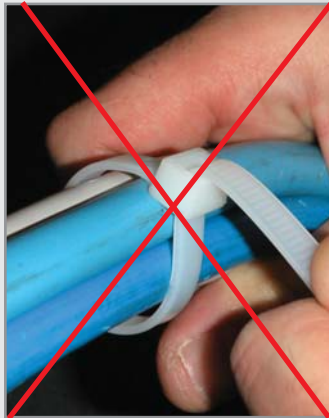



MANUAL INSTALLATION OF STANDARD CABLE TIES

			
Insert the tip of the tie.	Tighten manually the tie till complete fixing of the cables.	Avoid sharp bending of the tie: it will not improve the fixing strength.	Cut the exceeding part of the tie, with a few mm of safety length.

TOOL INSTALLATION OF STANDARD CABLE TIES

			
Set the max tension of the tool depending on the size of the tie.	Grip the tie with the tool.	Tighten the tie till complete fixing of the cables.	Cut the exceeding part of the tie.

TOOL INSTALLATION OF BELTURING CABLE TIES

			
Insert the tip of the tie and tighten a short segment.	Use the tool for tightening the tie around the cables.	Tighten the tie till complete fixing of the cables.	Cut the exceeding part of the tie with the tool, leaving at least one centimeter of safety length.



Quality System

ISO 9001:2008

The company is certified ISO 9001:2008 for the design and manufacturing of cable ties and fixing systems with engineering polymers. Trading of fixing, cabling systems and electrical power tools. This certification guarantees that all the steps of our company processes, from development to delivery, are controlled following detailed procedures.

ISO 14001:2004

The company has obtained ISO 14001:2004 certification for the activity: design and manufacturing of cable ties and fixing systems with engineering polymers through injection moulding process. Trading of fixing and cabling accessories.

Voluntary product certifications through international approval societies

UL - File E86244

Elematic Cable Ties are recognized by the Underwriters Laboratories Inc. following the norm UL 1565 "Wire positioning devices" for the continuous use at a max temperature of 85°C.

R.I.Na. Certificate ELE158207CS

Italian Naval Register omologation following the norm IEC EN 60092-101 "Electrical installation in ship".

GL Germanisches Lloyd certificate Nr. 99 332 - 97 HH

Certifies the mechanical properties and the flame resistance of the Elematic cable ties.

DNV - File E6996

Guarantees that the Elematic cable ties comply the "Det Norske Veritas" standards for the securing of cables in the naval constructions and offshore, for indoor and outdoor installations.

LLOYD'S REGISTER - Type Approval Certificate N° 09/00025

Certifies the mechanical properties and the flame resistance of Elematic cable ties in the shipbuilding and offshore applications.

BUREAU VERITAS - Certificate n° 13190/B1 BV

This homologation, according to IEC 60092 - EN 50146 normative, assures that Elematic Cable Ties are made in accordance to "Bureau Veritas" standards for the fixing cables in shipbuilding.

Self declarations

CE marking

Elematic certifies the conformity of its cable ties to the European instruction 73/23/CEE and following modification 93/68/CEE.

CEI EN 50146 - CEI - IEC 62275

Elematic cable ties are internally tested following the European Norm "Cable Ties for Electrical Installation". The results are in accordance with the requirements of the regulation.

RoHS - WEEE - ELV

Material used for Elematic cable ties & Accessories are compliant to European directives regarding:

- RoHS - restriction on hazardous substances (2002/95/CE),
- WEEE - waste of Electrical and Electronic Equipment (2002/96/CE),
- ELV - life vehicles (2000/53/CE).

REACH (2006/1907/CE)

In our products there are no substances in the "Candidate list of authorization" published in October 2008 and updated on 13th January 2010.

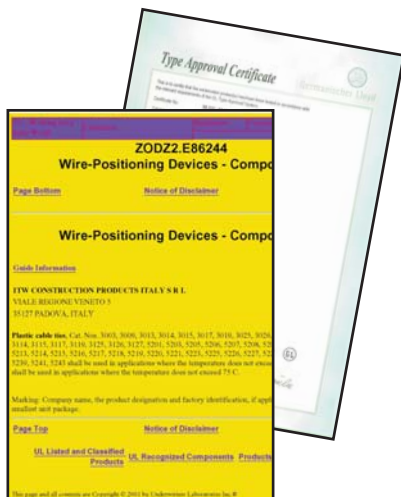

CABLE TIES & ACCESSORIES		Page
POLYAMIDE 6.6 STANDARD CABLE TIES		20
COLSPEED - BELTURING PLUS CABLE TIES		23 - 24
COLSTEEL CABLE TIES		26
SPECIAL CABLE TIES		28
CABLE TIES ACCESSORIES		31
FIXING ACCESSORIES		37
NYLON, POLYESTER AND FIBREGLASS DUCT RODS		46
CABLE CONNECTORS		
TERMINAL BLOCKS		56
PREINSULATED COPPER TERMINALS		62
TWIN TERMINALS - COPPER TERMINALS		65
INSULATED CRIMPING TERMINALS		68
HEAT SHRINKABLE BUTT CONNECTOR		74
COPPER LUGS		75
CABLE PROTECTION		
WIRING SPIRALS		80
BRAIDED SLEEVES		81
PVC TUBING SLEEVES		84
HEAT SHRINKABLE TUBING		86
NEOPRENE SLEEVES		113
ELECTRICAL INSULATION TAPES		114
CABLING TOOLS		
TOOLS FOR CABLE TIES		120
CRIMPING TOOLS		118
TOOLS FOR TERMINALS		122
CABLE STRIPPERS AND CUTTERS		127

TECHNICAL PARAMETERS OF RAW MATERIALS

Material	Working temperature	Colour	UL-rating flame	Moisture absorption		Characteristics
				23°C 50% U.R.*	Saturation	
Polyamide 6.6	-40°C ÷ 85°C	natural / black	UL 94-V2	2,7%	8,5%	Polyamide 6.6 injection moulding grade. Good resistance to bases, oils, greases, fuel, oil derivatives.
Polyamide 6.6 Heat stabilized 6.6	-40°C ÷ 125°C	natural / black	UL 94-V2	2,7%	8,5%	Polyamide 6.6 heat-stabilized for endurance applications to high temperatures.
Polyamide 6.6 UV stabilized	-40°C ÷ 105°C	black	UL 94-V2	2,7%	8,5%	Polyamide 6.6 UV for improved weather resistance.
Polyamide 6.6 Self-extinguishing	-40°C ÷ 85°C	natural	UL 94-V0	2,7%	8,5%	Self-extinguishing polyamide (halogen and phosphor-free).
Belturing Plus	-45°C ÷ 85°C	black	UL 94-HB	0,6%	1,2%	Good resistance to UV rays and weather. Improved shock resistance. Reduced moisture absorption.
Polyethylene HD	-40°C ÷ 100°C	white	UL 94-HB	-	-	High-density polyethylene. Good shock resistance.
Polyethylene LD	-50°C ÷ 90°C	natural/black white	UL 94-HB UL 94-V2	-	-	Low-density polyethylene. Good shock resistance.
Polyamide 6	-10°C ÷ 65°C	black	UL 94-HB	3,0%	9,5%	Polyamide 6 for moulding injection.
Polypropylene	-10°C ÷ 105°C	natural	UL 94-HB	-	-	Resistant to high temperatures, without any absorption of humidity. Good resistance to bases and weak acids.
ABS	-10°C ÷ 60°C	natural / black	UL 94-HB	0,3%	-	ABS injection moulding grade. Good shock resistance, good resistance to inorganic salts, bases, alcohols and hydrocarbides. Good heat resistance. Low moisture absorption.
PVC	-10°C ÷ 70°C	natural	UL 94-V0	-	-	Rigid PVC. Low resistance to organic compounds and solvents. Good aging resistance. No moisture absorption.
Polycarbonate	-5°C ÷ 85°C	transparent	ULV 94-V0	-	-	Low resistance to chemical agents and solvents. Good UV resistance.

*R.H.=relative humidity

STANDARD CABLE TIES

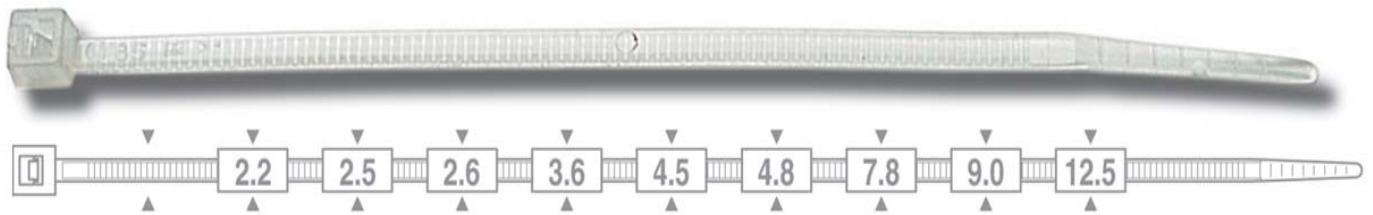

Characteristics:

Material: Polyamide 6.6
 Humidity absorption: 2,7% (50% relative humidity)

- Working temperature: $-40^{\circ}\text{C} \div 85^{\circ}\text{C}$
- Tightening temperature: $-10^{\circ}\text{C} \div 60^{\circ}\text{C}$
- Max admissible point: $+110^{\circ}\text{C}$ for short time
- Melting temperature: $+256^{\circ}\text{C}$

Limit Oxygen Index (LOI): 27%
 Flammability rating: UL 94 class V2.

Tested according to EN 50146

- High resistance to bases, oils, greases, oil derivatives.
- Limited resistance to acids.
- Not resistant to phenols and to chloride solvents.
- Halogen-free resins.
- UV resistance (black color).

EC Directives:

The raw material used to produce our cable ties is compliant with EC Directives:

- 2000/53/EC (ELV)
- 2002/95/EC (RoHS)
- 2002/96/EC (WEEE)
- 2003/11/EC

Applications

- Electrical installations.
- Industrial Wiring.
- Automotive.
- Panel building.
- Special applications.

Characteristics

- Our Cable Ties are made exclusively of polyamide 6.6 so that they do not cause issues of material separation during recycling or interferences in electronic equipments.
- In the black cable ties the added carbon black gives an UV resistance according to ISO 4892 (QUV-B 150 hours), compared to 3 years of outdoor exposure under the sunlight and UV action.

Benefits

- Smooth rounded edges make them easier to be handled and safer to be installed.
- Bent rounded tip allows easier insertion through the head of the cable ties.
- Low friction coefficient of the material.



Tools for cable ties, see pages 120-121.

Our cable ties are constantly tested in our laboratories following important international standards. Particular extreme cable ties uses, weather conditions or even unsuitable applications might nevertheless vary some of the data we declare. Therefore, in case of specific enquiries or problems, do not hesitate to contact us. We will be pleased to share our experience with You.



Polyamide 6.6 cable ties width 2,2 ÷ 12,5 mm



Code	Code	Dimensions	Ø Bundle	Tensile strength		Bag	Carton
Natural	Black	(mm)	max (mm)	(kg)	(N)	pcs	pcs
5201/CE	5301/CE	2,2x75	15	6,12	60	100	20.000
5201E	5301E	2,2x75	15	6,12	60	1.000	100.000
5203/CE	5303/CE	2,5x98	21	8,16	80	100	15.000
5203E	5303E	2,5x98	21	8,16	80	1.000	50.000
5203/B2	5303/B2	2,5x98	21	8,16	80	20.000	20.000
5205/CE	5305/CE	2,5x135	32	8,16	80	100	12.000
5205E	5305E	2,5x135	32	8,16	80	1.000	30.000
5206/CE	5306/CE	2,6x160	40	8,16	80	100	10.000
5206E	5306E	2,6x160	40	8,16	80	1.000	30.000
5207/CE	5307/CE	2,6x200	52	8,16	80	100	8.000
5207E	5307E	2,6x200	52	8,16	80	1.000	25.000
5209/CE	5309/CE	3,6x140	35	13,26	130	100	7.000
5209E	5309E	3,6x140	35	13,26	130	1.000	25.000
5214/CE	5314/CE	3,6x200	50	13,26	130	100	7.000
5214E	5314E	3,6x200	50	13,26	130	1.000	20.000
5210/CE	5310/CE	3,6x290	80	13,26	130	100	4.500
5210E	5310E	3,6x290	80	13,26	130	500	15.000
5208E	5308E	3,6x370	103	13,26	130	100	4.000
5212/CE	5312/CE	4,5x120	24	22,44	220	100	8.000
5212E	5312E	4,5x120	24	22,44	220	1.000	20.000
5211/CE	5311/CE	4,5x160	40	22,44	220	100	6.000
5211E	5311E	4,5x160	40	22,44	220	1.000	18.000
5213/CE	5313/CE	4,8x178	45	22,44	220	100	5.000
5213E	5313E	4,8x178	45	22,44	220	1.000	15.000
5215/CE	5315/CE	4,8x200	50	22,44	220	100	4.000
5215E	5315E	4,8x200	50	22,44	220	1.000	14.000
5216/CE	5316/CE	4,8x250	68	22,44	220	100	4.500
5217E	5317E	4,8x290	78	22,44	220	100	3.500
5219E	5319E	4,8x360	100	22,44	220	100	3.000
5218E	5318E	4,8x390	106	22,44	220	100	7.000
5220E	5320E	4,8x430	115	22,44	220	100	6.000
5221E	5321E	7,8x120	25	55,08	540	100	4.000
5223E	5323E	7,8x180	45	55,08	540	100	2.500
5225E	5325E	7,8x240	63	55,08	540	100	2.000
5226E	5326E	7,8x300	80	55,08	540	100	1.500
5227E	5327E	7,5x365	100	55,08	540	100	1.500
5229E	5329E	7,5x450	130	55,08	540	100	3.000
5231E	5331E	7,5x540	158	55,08	540	100	2.000
5233E	5333E	7,8x750	220	55,08	540	100	2.000
5234E	5334E	9,0x780	233	71,4	700	100	1.300
5235E	5335E	12,5x225	57	110	1.080	50	2.000
5237E	5337E	12,5x500	143	110	1.080	50	1.000
5239E	5339E	12,5x720	213	110	1.080	50	1.000
5241E	5341E	12,5x850	255	110	1.080	50	1.500
5243E	5343E	12,5x1000	302	110	1.080	50	1.000

*The nominal dimensions can slightly change according to the utilized mould.

COLOURED CABLE TIES - polyamide 6.6 width 2,5 ÷ 4,8 mm

5203/C *E	2,5x98	21	8,16	80	100	15.000
5209/C *E	3,6x140	32	13,26	130	100	7.000
5214/C *E	3,6x200	50	13,26	130	100	7.000
5215/C *E	4,8x200	50	22,44	220	100	4.000
5217 *E	4,8x290	78	22,44	220	100	3.500

* ♦ R=Red, ♦ G=Yellow, ♦ V=Green, ♦ B=Blue

Minimum order quantity: 1 carton. Other colours and dimensions available on request.

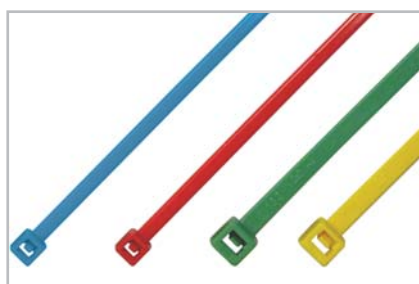



CABLE TIES ROTATING DISPLAY - (with fixed hooks)

Code display: **8312500**
 Height: 76 cm - Width: 26 cm - Depth: 26 cm

This cable ties display can contain 7 different dimensions of cable ties (from cod. 5x01/CE up to 5x27E) for a max quantity of 5 cable ties bags for hook.



CABLE TIES FLOOR DISPLAY - (with moving hooks)

Code display **8222200**
 Height: 202 cm - Width: 54 cm - Depth: 36 cm

This cable ties floor display, with moving hooks, can contain 30 different dimensions of cable ties for a max quantity of 7 cable ties bags for hook.

Composition of the cable ties floor display

Cable ties composition: 8222212			
5203/CE	n. 7 bags 100 pcs.	2,5x135 mm	natural
5205/CE	n. 7 bags 100 pcs.	2,5x135 mm	natural
5207/CE	n. 7 bags 100 pcs.	2,6x200 mm	natural
5208E	n. 7 bags 100 pcs.	3,6x370 mm	natural
5209/CE	n. 7 bags 100 pcs.	3,6x140 mm	natural
5210/CE	n. 7 bags 100 pcs.	3,6x290 mm	natural
5214/CE	n. 7 bags 100 pcs.	3,6x200 mm	natural
5216/CE	n. 7 bags 100 pcs.	4,8x250 mm	natural
5219E	n. 7 bags 100 pcs.	4,8x390 mm	natural
5225E	n. 7 bags 100 pcs.	7,8x240 mm	natural
5303/CE	n. 7 bags 100 pcs.	2,5x98 mm	black
5305/CE	n. 7 bags 100 pcs.	2,5x135 mm	black
5307/CE	n. 7 bags 100 pcs.	2,6x200 mm	black
5308E	n. 7 bags 100 pcs.	3,6x370 mm	black
5309/CE	n. 7 bags 100 pcs.	3,6x140 mm	black
5310/CE	n. 7 bags 100 pcs.	3,6x290 mm	black
5314/CE	n. 7 bags 100 pcs.	3,6x200 mm	black
5316/CE	n. 7 bags 100 pcs.	4,8x250 mm	black
5319E	n. 7 bags 100 pcs.	4,8x390 mm	black
5325E	n. 7 bags 100 pcs.	7,8x240 mm	black



WIRING AND FIXING SYSTEMS FLOOR DISPLAY

Code display **8221701**
 Height: 225 cm - Width: 103 cm - Depth: 56 cm

Floor display with hooks and shelves.
 For further information, please contact our sales department.

COLSPEED CABLE TIES

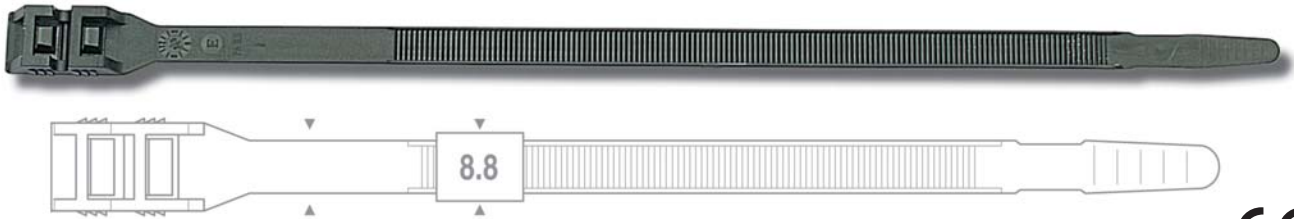

Characteristics:

Material: Polyamide 6.6
 Humidity absorption: 2,7%
 (50% relative humidity)

- Working temperature -40°C +85°C
- Tightening temperature -10°C +60°C
- Max admissible point +110°C for short time
- Melting temperature +256°C

Limit Oxygen Index (LOI): 27%
 Flammability rating: UL 94 class V2.

Tested according to EN 50146 and EDF HN 33 S 62

- High resistance to bases, oils, greases, oil derivatives.
- Limited resistance to acids.
- Not resistant to phenols and to chloride solvents.
- Halogen-free resins.
- UV resistance.

EC Directives:

The raw material used to produce these cable ties is compliant with EC Directives:
 2000/53/EC (ELV)
 2002/95/EC (RoHS)
 2002/96/EC (WEEE)
 2003/11/EC



Applications

- Electrical installations.
- Industrial Wiring.
- Automotive.
- Panel building.
- Special applications.
- External application.

Characteristics

- The flat head, the high surface and the closing system with external teeth of these Cable Ties, make them particularly suitable for applications on suspended lines, avoiding problems of insulation damage.
- In the Colspeed cable ties the added carbon black gives an UV resistance according to ISO 4892 (QUV-B 150 hours), compared to 3 years of outdoor exposure under the sunlight and UV action.

Benefits

- Ensure a permanent installation.
- Bent "tooth".
- Bent rounded tip for the safest application.
- Smooth rounded edges make them easier to be handled and installed.



Tools for cable ties, see pages 120-121.

Code	Dimension	Head	Ø Bundle	Tensile strength		Bag	Cartoon
Black	(mm)		max (mm)	(kg)	(N)	pcs	pcs
6501E	8,8X200	TS	40	36,72	360	100	4.500
6502E	8,8X290	TD	70	55,08	540	100	3.000
6503E	8,8X380	TD	100	55,08	540	100	2.000

• TS = single head • TD = double head

BELTURING PLUS CABLE TIES

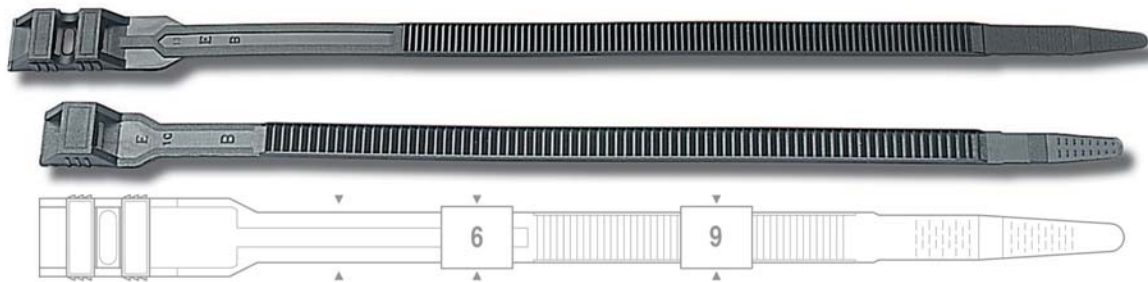

Characteristics:

Humidity absorption: <1%

• Working temperature da -45°C a +85°C
 • Tightening temperature da -30°C a +60°C
 • Max admissible point +120°C for short time

Limit Oxygen Index (LOI): 22% (EN ISO 4589-1 and ASTM D 2863-00)
 Flammability rating: UL 94 class HB.
 Halogen-free resins.
 Tested according to EN 50146 and EDF HN 33 S 62

- High UV resistance.
- High resistance to bases, oils, greases, oil derivatives.
- Limited resistance to acids.
- Not resistant to phenols and to chloride solvents.
- Halogen-free resins.

EC Directives:

The raw material used to produce these cable ties is compliant with EC Directives:
 2000/53/EC (ELV)
 2002/95/EC (RoHS)
 2002/96/EC (WEEE)
 2003/11/EC



Applications

- Electrical installations.
- Industrial wiring.
- Automotive.
- Panel building.
- Special applications.
- Outdoor uses.

Characteristics

The flat head, the high surface and the closing system with external teeth of these Cable Ties make them particularly suitable for applications on suspended lines, avoiding problems of insulation damage.

Benefits

- Highly withstands climatic changes, also in sea-areas.
- High UV resistance.
- Halogen-free resins.



Tools for cable ties, see pages 121.



TEMPORARY INSTALLATION (RELEASABLE CABLE TIE)



DEFINITIVE INSTALLATION



Belturing Plus Cable Ties - SINGLE HEAD

Code	Dimension (mm)	Ø Bundle max (mm)	Tensile strength		Bag pcs	Carton pcs
			(Kg)	(N)		
6449XE	115x6	25	28,56	280	100	9.000
6450XE	180x6	45	28,56	280	100	6.000
6452XE	290x6	78	28,56	280	100	4.800
6454XE	360x6	100	28,56	280	100	1.500
6447XE	132x9	27	39,78	390	100	4.800
6451XE	180x9	40	39,78	390	100	4.800



Belturing Plus Cable Ties - DOUBLE HEAD

Code	Dimension (mm)	Ø Bundle max (mm)	Tensile strength		Bag pcs	Carton pcs
			(Kg)	(N)		
6453XE	260x9	62	55,08	540	100	2.800
6448XE	300x9	80	55,08	540	100	1.500
6455XE	360x9	93	55,08	540	100	1.500
6456XE	510x9	140	55,08	540	100	1.000
6457XE	760x9	220	55,08	540	100	800

A very practical box that can easily be hung to your belt. Its convenient upper opening, very easy to be reclosed, allows the quickest picking-up of the product and the best protection from dust.



Cable ties COLSTEEL



Cable ties made in stainless steel 304 with ball lock system.

Characteristics:

Material: Stainless steel 304
Operating temperature: $-80^{\circ}\text{C} \div 538^{\circ}\text{C}$.

Uninflammable.

Resistance to external agents:

- Outstanding resistance to acid, oils, greases, chemicals, solvents.
- High resistance to the seawater and to corrosive atmosphere.
- Excellent resistance to UV rays.
- Stainless steel 316 on request.

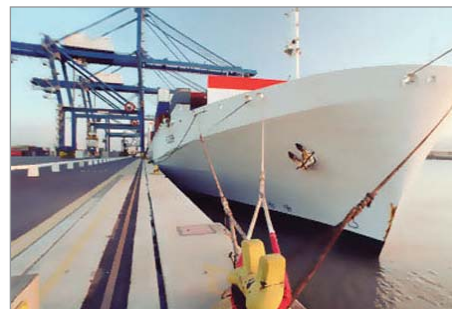

Applications

For heavy duty applications and where a great resistance to corrosion, high temperature, fire, chemicals and atmospheric agents are required. These cable ties are particularly used in shipbuilding, mining, oil rigs, food industry, theatre, cinemas and exhibition halls.

Characteristics

- High resistance to corrosion.
- High tensile strength.
- No absorption of humidity.
- High resistance to very high temperature and flame.
- High resistance to atmospheric agents and UV rays.
- Outstanding chemical and corrosion resistance.

Benefits

- The ball lock system allows a little effort and permit the closing adjust in continuous.
- It is possible to lock the cable ties by hand or with the dedicated tool (code 5407).
- The easy closing system allows to save time during the installation.
- They can be put like fire assurance when other plastic cable ties are used (i.e. in the ship technological plants).
- The absence of flashes and cutting edges avoid damages on the cable electrical insulation.

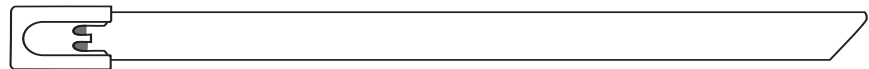

Stainless steel cable ties

Cod.	Dimensions (mm)	∅ Bundle max (mm)	Thickness (mm)	Tensile strength (Kg) (N)		Bag pcs
6701	4,6x127	25	0,25	46	450	100
6703	4,6x201	50	0,25	46	450	100
6706	4,6x266	67	0,25	46	450	100
6708	4,6x362	102	0,25	46	450	100
6710	4,6x521	152	0,25	46	450	50
6712	4,6x838	254	0,25	46	450	50
6719	7,9x201	50	0,25	114	1118	100
6720	7,9x266	67	0,25	114	1118	100
6722	7,9x362	102	0,25	114	1118	100
6724	7,9x521	152	0,25	114	1118	50
6726	7,9x838	254	0,25	114	1118	50
6728	7,9x1067	305	0,25	114	1118	50



Tool for cable ties

Cod.	L (mm)	Weight (gr.)	Packaging pcs
5407	178	560	1

Tool for stainless steel cable ties with width up to 7,9 mm. Made in a strong metallic structure, it allows to adjust the tightening strength with the screw under the handle. When the set tension is reached, the blade cuts off the tail of the ties without effort and flashes.

SPECIAL CABLE TIES

Cable ties available on request. Minimum order quantities are applied.



These cable ties, made of polyamide 6.6 with additives, can be used for operating temperatures up to 125°C /145°C for short time.

Operating temperature: -40°C ÷ 125°C
Flammability rating: UL-94 V2.

HEAT RESISTANT cable ties (-40°C +125°C)

Code	Code	Dimension	Ø Bundle	Tensile strength		Bag	Carton
Natural	Black	(mm)	max (mm)	(kg)	(N)	pcs	pcs
5203/C TE	5303/C TE	2,5x98	21	8,16	80	100	40.000
5209/C TE	5309/C TE	3,6x140	32	13,26	130	100	25.000
5214/C TE	5314/C TE	3,6x200	50	13,26	130	100	20.000
5215/C TE	5315/C TE	4,8x200	50	22,44	220	100	13.000
5217 TE	5317 TE	4,8x290	78	22,44	220	100	10.000
5227 TE	5327 TE	7,5x365	100	55,08	540	100	3.500



These cable ties are made with a special compound that assures an UV resistance according to ISO 4892 (QUV-B 600 hours), compared to 10 years of outdoor exposure under the sunlight and UV action.

Operating temperature: -40°C ÷ 105°C
Flammability rating: UL-94 V2.

UV AND WEATHER RESISTANT cable ties (UL 94 - V2) - for outdoor use

Code	Dimension	Ø Bundle	Tensile strength		Bag	Carton
Black	(mm)	max (mm)	(kg)	(N)	pcs	pcs
5303/C UVE	2,5x98	21	8,16	80	100	40.000
5309/C UVE	3,6x140	35	13,26	130	100	25.000
5314/C UVE	3,6x200	50	13,26	130	100	20.000
5315/C UVE	4,8x200	50	22,44	220	100	13.000
5317 UVE	4,8x290	78	22,44	220	100	10.000
5327 UVE	7,5x365	100	55,08	540	100	3.500



These cable ties, made of polyamide 6.6 with additives, can be used where the auto extinguishing performance is required. They conform with UL-94 V0 and GW 960°C standards and the halogen and phosphorus free material avoids toxic emission in event of fire.

Operating temperature: -40°C ÷ 85°C
Flammability rating: UL-94 V0.

SELF-EXTINGUISHING cable ties (UL 94 - V0) - GW 960°C

Code	Dimension	Ø Bundle	Tensile strength		Bag	Carton
Natural	(mm)	max (mm)	(kg)	(N)	pcs	pcs
5203/C VOE	2,5x98	21	8,16	80	100	40.000
5209/C VOE	3,6x140	35	13,26	130	100	25.000
5214/C VOE	3,6x200	50	13,26	130	100	20.000
5215/C VOE	4,8x200	50	22,44	220	100	13.000
5217 VOE	4,8x290	78	22,44	220	100	10.000
5227 VOE	7,5x365	100	55,08	540	100	3.500



The polyamide 6.6 cable ties with marking plate, allow a quick identification through specific marking on the plate.

Operating temperature: -40°C ÷ 85°C
Flammability rating: UL-94 V2.

IDENTIFICATION CABLE TIES

Code	Dimension (mm)	Plate height (mm)	Plate width (mm)	Ø Bundle max (mm)	Tensile strength		Bag pcs	Carton pcs
					(kg)	(N)		
52100-ME	2,5x100	8	25,4	20	8,16	80	100	10.000
52200-ME	2,5x200	8	25,4	50	8,16	80	100	7.500



IDENTIFICATION CABLE TIES

Code	Dimension (mm)	Plate height (mm)	Plate width (mm)	Ø Bundle max (mm)	Tensile strength		Bag pcs	Carton pcs
					(kg)	(N)		
52110-ME	2,5x110	9,1	20,4	20	8,16	80	100	10.000
52210-ME	2,5x210	9,1	20,4	52	8,16	80	100	7.500



IDENTIFICATION CABLE TIES

Code	Dimension (mm)	Plate height (mm)	Plate width (mm)	Ø Bundle max (mm)	Tensile strength		Bag pcs	Carton pcs
					(kg)	(N)		
52190-ME	4,8x190	28	13	48	22,44	220	100	5.000
52270-ME	4,8x270	28	13	68	22,44	220	100	4.000



The nylon 6.6 releasable cable ties allow a quick and simple release of the ties. They are ideal for temporary installations or when the addition or removal of cables is required.

Operating temperature: -40°C ÷ 85°C
Flammability rating: UL-94 V2.

RELEASABLE CABLE TIES

Code nat.	Code black	Dimension (mm)	Ø Bundle max (mm)	Tensile strength		Bag pcs	Carton pcs
				(kg)	(N)		
5250E	5350E	7,5x200	50	22,44	220	100	7.500
5252E	5352E	7,5x250	65	22,44	220	100	5.000
5254E	5354E	7,5x350	100	22,44	220	100	4.500

* Coloured cable ties available on request.

◆ R=Red, ◆ G=Yellow, ◆ V=Green, ◆ B=Blue

The Polyamide 6.6 push mount cable ties are used for fixing cables to panels with thickness up to 3 mm.

Operating temperature: $-40^{\circ}\text{C} \div 85^{\circ}\text{C}$
 Flammability rating: UL-94 V2.

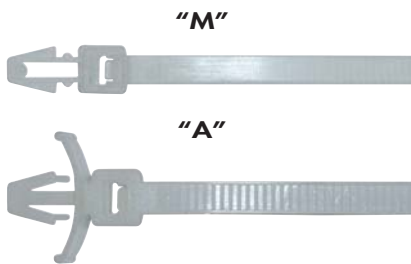

PUSH MOUNT CABLE TIES

Code	Dimension	Ø Hole	Panel thickness	Ø Bundle max	Tensile strength		Bag	Carton
	(mm)	(mm)	(mm)	(mm)	(kg)	(N)	pcs	pcs
52155-ME	3,5x150	5,2	2,7	38	13,26	130	100	7.500
52205-ME	4,5x200	6,3	3,0	50	22,44	220	100	5.000
52203-A	4,5x100	6,3	3,0	50	22,44	220	100	5.000
52204-A	4,5x150	6,3	3,0	50	22,44	220	100	5.000
52205-A	4,5x200	6,3	3,0	50	22,44	220	100	5.000



The Polyamide 6.6 cable ties with mounting hole are used for bundling the cables with a screw or bolt.

Operating temperature: $-40^{\circ}\text{C} \div 85^{\circ}\text{C}$
 Flammability rating: UL-94 V2.

CABLE TIES WITH MOUNTING HOLE

Code	Dimension	Ø Bundle max	Tensile strength		Ø Hole	Bag	Carton
	(mm)	(mm)	(kg)	(N)	(mm)	pcs	pcs
52150-IE	3,6x150	2	13,26	130	4,5	100	7.500
52200-SE	4,8x200	50	22,44	220	5,2	100	5.000
52200-HE	7,8x200	44	55,08	540	6,5	100	3.000
52300-HE	7,8x300	75	55,08	540	6,5	100	2.000
52380-HE	7,8x380	104	55,08	540	6,5	100	2.000

The Polyamide 6.6 cable tray ties are used for fixing the cables to the cable tray.

Operating temperature: $-40^{\circ}\text{C} \div 85^{\circ}\text{C}$
 Flammability rating: UL-94 V2.

CABLE TRAY TIES*

Code	Dimension	Tensile strength		Bag	Carton
	(mm)	(kg)	(N)	pcs	pcs
5346	7,8x (24 + 270)	55,08	540	100	2.000
5347	12,6x (50 + 275)	110,16	1.080	50	1.000

* Cable Ties available on request and minimum quantities.

CABLE TIES ACCESSORIES

CABLE TIES SUPPORTS

Applications

Fixing of cables and pipes.
Installation temperature: > -5°C

Characteristics

Polyamide 6 black (carbon black).
Available in black and white colours
(characteristics on page 19).

Benefits

Very easy installation: for cable ties up to 9 mm width. Two different types for different wall distances.

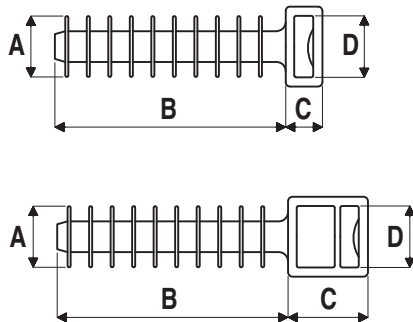

WALLPLUG BASES FOR CABLE TIES polyamide 6

Code	Code	Ø Hole (mm)	Dimensions (mm)				Bag pcs	Carton pcs
			A	B	C	D		
5456 AE	5456 AWE	6	7,8	30,7	6,3	9,6	100	5.000
5458E	5458 WE	8	10,0	37,0	6,5	9,7	100	5.000
5458 AE	-	8	10,0	37,0	6,5	9,7	100	5.000
5459E	-	8	10,0	37,0	13	9,7	100	4.000

* Grey colour on request.

Applications

Fixing of cables and pipes.

Characteristics

Polyamide 6.6 black (carbon black).
The support is provided with M6/7
thread, can therefore be fixed with plug
cod. 566112.
(characteristics on page 19)

Benefits

For cable ties up to 9 mm width. Suitable for
either countersunk or flat headed screws.
For wall plug max 8 mm.

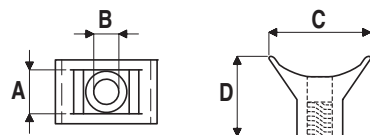

CABLE TIE SUPPORT in polyamide 6.6 for cable ties width up to 9 mm

Code	Dimensions (mm)				Thread	Bag pcs	Carton pcs
	A	B	C	D			
1041301E	9,4	5	23	17,6	M6/7	100	10.000



THREADED WALL PLUG M6/7 in polyamide 6.6 for cable tie support

Code	Length (mm)	Ø Hole (mm)	Thread	Bag pcs	Carton pcs



Applications

Fixing of cables and pipes.

Characteristics

Polyamide 6.6 black (carbon black).
(characteristics on page 19)

Benefits

Fast fixing with hammer-in anchor
(our UCX Ø 5x36 mm).
For cable ties up to 9 mm width.



CABLE TIE SUPPORT in polyamide 6.6 with anchor

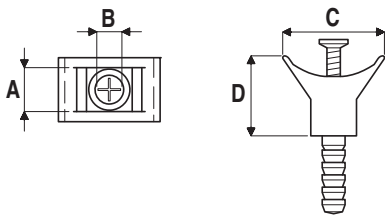

Code	Dimensions (mm)				Bag pcs	Carton pcs
	A	B	C	D		
1041303	9,4	5	23	17,6	100	10.000

Applications

Electrical panels.

Characteristics

Polyamide 6.6.
(characteristics on page 19)
For cable ties width max 9 mm.

Benefits

Fixing with screw or rivet.



CRADLES IN POLYAMIDE 6.6

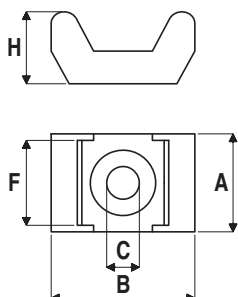

Code Natural	Code Black	Cable ties width (mm)	Dimensions (mm)					Bag pcs	Carton pcs
			A	B	C	F	H		
5498	5499	5	9,5	15	3,5	5	7	100	10.000
5496E	5497E	9	14,6	22,5	5	9,3	11	100	5.000

Applications

Electrical panels.

Characteristics

Polyamide 6.6.
(characteristics on page 19)

Benefits

Fixing with screw or rivet.



EYELETS IN POLYAMIDE 6.6

Code	Code	Cable ties	Dimensions (mm)					Bag	Carton
			width (mm)	A	B	C	F		
Natural	Black							pcs	pcs
5460E	5461E	4,8	10	19	4,1	5	6	100	10.000

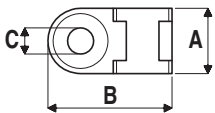
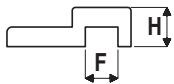

Applications

Suspended electrical installations.

Characteristics

Polyamide 6.6 black (carbon black).
(characteristics on page 19)

Benefits

Enables cables to be secured to posts or pipes by passing two ties through the rectangular hole.



TWIN TIE DEVICE in polyamide 6.6

Code	Dimensions (mm)			Bag	Carton
	A	B	C		
1041302E	9,3	9,5	21,3	100	10.000

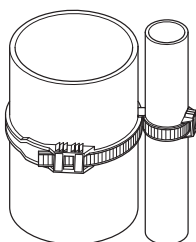
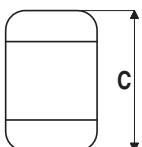
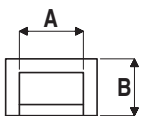

Applications

For use in pre-drilled or punched holes on plates with thickness up to 3 mm. Hole Ø 6,5 mm.

Characteristics

Polyamide 6.6. (characteristics on page 19)

Benefits

Suitable for applications on sheet-steel, with cable ties up to 7,8 mm width.



ARROWHEAD CRADLE

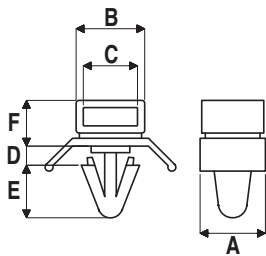

Code	Dimensions (mm)						Ø Fixing hole (mm)	Bag pcs	Carton pcs
	A	B	C	D	E	F			
104300	10	10,6	8,1	3	8	7,1	6,5	100	17.000

IDENTIFICATION PLATE BADGES

Applications

Electrical panels, cable bundles.

Characteristics

Material: polyamide 6.6. (characteristics on page 19)

Benefits

Quick and economic solution for the identification of a bundle of cables.



IDENTIFICATION PLATE BADGES*

Code	Type (mm)	Length (mm)	Width (mm)	Bag pcs
104293	A	60,5	25,2	100
104291	B	26,4	16,2	100
104292	C	40,3	20,5	100
104294	D	59,9	49,9	100

*IMPORTANT: these identification plates can be attached around a cable harness with cable ties up to 4,8 mm wide.

MOUNTING BASES - SINGLE WAY

Applications

They are used with cable ties, for routing and securing wire bundles or cables. Their thin profile allows use in limited areas.

Operating temperature: $-10^{\circ}\text{C} \div 60^{\circ}\text{C}$
 Flammability rating: UL 94-HB.

Characteristics

Material: ABS.
 (characteristics on page 19)
 Self adhesive bases with 2 different types of adhesive foam: rubber base, acrylic base.

The rubber base adhesives: are particularly suitable for immediate applications.

The acrylic base adhesive: is instead more suitable for long period applications and where a good UV ray resistance is required.

Benefits

Easy to apply.
 Suitable for cable ties up to 4,8 mm width.

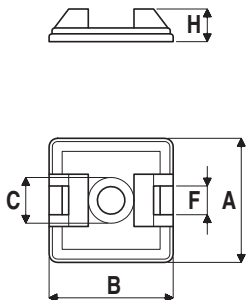

mounting bases **WITHOUT ADHESIVE** (application with screw)

Code	Code	Cable ties	Dimensions (mm)					Bag	Carton
Natural	Black	width (mm)	A	B	C	F	H	pcs	pcs
5421E	5423E	3,6	19	19	4,2	4	5	100	10.000
5422E	5424E	4,8	27	27	4,2	6	7,4	100	5.000

mounting bases **WITH RUBBER BASE ADHESIVE**

Code	Code	Cable ties	Dimensions (mm)					Bag	Carton
Natural	Black	width (mm)	A	B	C	F	H	pcs	pcs
5426 RBE	5428 RBE	3,6	19	19	4,2	4	5	100	10.000
5427 RBE	5429 RBE	4,8	27	27	4,2	6	7,4	100	5.000

mounting bases **WITH ACRYLIC BASE ADHESIVE**

Code	Code	Cable ties	Dimensions (mm)					Bag	Carton
Natural	Black	width (mm)	A	B	C	F	H	pcs	pcs
5426 3MVE	5428 3MVE	3,6	19	19	4,2	4	5	100	10.000
5427 3MVE	5429 3MVE	4,8	27	27	4,2	6	7,4	100	5.000

ADHESIVE DATA SHEET

Adhesive data sheet	u.m.	rubber base	acrylic base
Bonding foam		polyethylene	polyester
Density	kg/m ³	100	320
500 hour static shear adhesion*	kg/cm ²	0,7	0,3
Maximum recommended weight loading*	kg/cm ²	0,36	0,15
Dynamic shear adhesion	kg/cm ²	4,1	8
Tensile strength	kg/cm ²	>10	>20
Elongation		>150%	>90%
U.V. resistance		not recommended	good
Service temperature		-40°C / +60°C	-40°C / +120°C
Recommended application		+15°C / +40°C	+15°C / +40°C
Use		immediate application	application after 24h rest

* On clean zinc metallic surfaces.

MOUNTING BASES - TWO WAYS

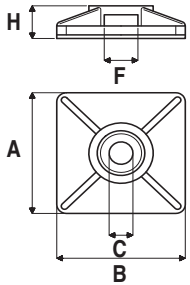
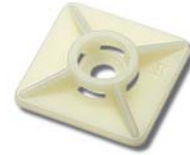

two way mounting bases **WITHOUT ADHESIVE** (application with screw)

Code	Code	Cable ties	Dimensions (mm)					Bag	Carton
Natural	Black	width (mm)	A	B	C	F	H	pcs	pcs
5466E	5468E	3,6	19	19	4,1	4	5	100	10.000
5472E	5474E	4,8	27	27	4,8	6	6,5	100	5.000

two way mounting bases **WITH RUBBER BASE ADHESIVE**

Code	Code	Cable ties	Dimensions (mm)					Bag	Carton
Natural	Black	width (mm)	A	B	C	F	H	pcs	pcs
5467 RBE	5469 RBE	3,6	19	19	4,1	4	5	100	10.000
5473 RBE	5475 RBE	4,8	27	27	4,8	6	6,5	100	5.000

two way mounting bases **WITH ACRYLIC BASE ADHESIVE**

Code	Code	Cable ties	Dimensions (mm)					Bag	Carton
Natural	Black	width (mm)	A	B	C	F	H	pcs	pcs
5467 3MVE	5469 3MVE	3,6	19	19	4,1	4	5	100	10.000
5473 3MVE	5475 3MVE	4,8	27	27	4,8	6	6,5	100	5.000

INSTALLATION INSTRUCTION FOR SELF ADHESIVE MOUNTING BASES



1 Clean the surface using an appropriate cleaner (e.g. isopropanol/water) avoiding to leave any residues.

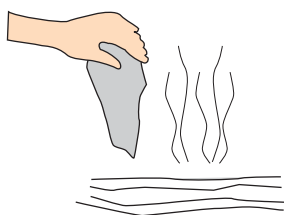

2 Wait until the cleaned surface is completely dried.

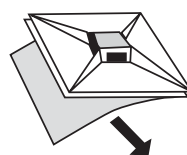

3 Peel off the protective film avoiding to touch the adhesive.

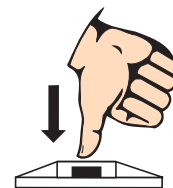

4 Put the base on the cleaned surface pressing down with the finger for several seconds.

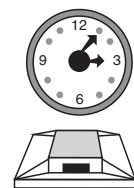

5 Wait for a certain time (minutes in case of syntetic rubber, hours in case of acrylate) to assure the max adhesion to the surface.

ELEFIX: PIPES FIXING SYSTEM



Characteristics:

Material: Polyamide 6.6
 Colours available: Grey, black UV resistant, white self-extinguishing.
 Sizes available: Ø 16 ÷ 32 mm; Ø 40 ÷ 63 mm.
 Width of the cable tie: 7,5 mm.

Temperature:
 • Working temperature -40°C ÷ 85°C
 • Tightening temperature -15°C ÷ 60°C

Threaded hole: M6/7 - 1,5 mm.

Flammability rating: UL 94 class V2 for grey and black ELEFIX.
 UL 94 V0 for white ELEFIX.

Max tensile strength: 360 N.



Applications

- ELEFIX is the practical and fast support for cables and pipes.
- It is available in three versions: the grey one is recommended for indoor applications, the black one, UV stabilized, is indicated for the maximum resistance against UV rays and atmosphere agents, and the white one is for applications needing glow wire 960°C resistance (public buildings, cinemas, theatres etc.).

Characteristics

- The two versions 16-32 mm. and 40-63 mm. allow the fixing of all pipes with a maximum diameter of 63 mm.

Benefits

- **THE UNIVERSAL FIXING.**
 The ELEFIX range with its accessories is suitable to be fixed to any material such as natural stone, concrete, hollow brick, plasterboard, composite boards and aerated concrete. 
- **THE ORIGINAL PACKAGING IS FUNCTIONAL AND COMMUNICATIVE OFFERING TO THE INSTALLERS THE MAXIMUM COMFORT ON APPLICATION.**
 The box contains an empty space for placing the case with the fixing accessories which are more suitable for the wished application. Such solution allows a fast and simple replacement of the fixing products, helping and improving the job organization and efficiency.

	natural stone	solid brick	concrete	hollow brick	lightweight concrete block	hollow brick	plaster-boards	composite boards	wood	aerated concrete
M6/7 ANCHOR 		● (85)								● (30)
UCX VM6 ANCHOR 		● (200)								
T6/VA6-8 ANCHOR 		● (350) (*)			● (230) (*)					● (100) (*)
SELF-DRILLING MINI DRIVA SCREW 							● (30)	● (30)	● (30)	● (30)
T-CLICK SELF-DRILLING ANCHOR 							● (90)	● (90)		● (90)
DRIVA SELF-DRILLING ANCHOR 							● (60)	● (60)	● (60)	● (60) *
DRIVA NYLON SELF-DRILLING 							● (40)	● (40) *		● (40) *

() recommended axial load of the fixing product in Newton (N) [10 N ≈ 1 kg]

(*) T6/VA8 anchor value

* with pre-drilling

M6/7 ANCHOR 	SELF-DRILLING MINI DRIVA SCREW
UCX VM6 ANCHOR 	DRIVA SELF-DRILLING ANCHOR
T6/VA6-8 ANCHOR 	TCLICK SELF-DRILLING ANCHOR
	DRIVA NYLON SELF-DRILLING ANCHOR

A COMPLETE RANGE FOR FIXING CABLES AND PIPES

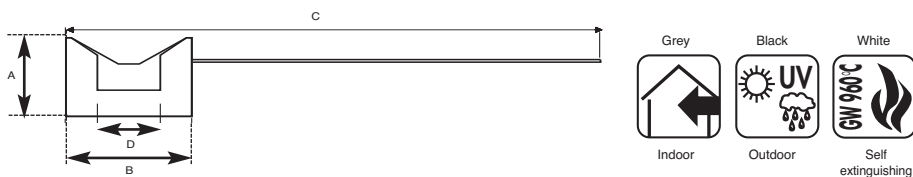

Type	Code	Ø Pipes (mm)	Colour	Applications	Dimension (mm)				Tensile strength (N)	Packaging	
					A	B	C	D		Box	Carton
ELEFIX 16-32	566246	16-32	grey	internal	17,6	24,5	180	5,9	360	100	1200
ELEFIX 40-63	566251	40-63	grey	internal	17,6	40,5	280	5,9	360	100	600
ELEFIX 16-32	566247	16-32	black UV stabilized		17,6	24,5	180	5,9	360	100	1200
ELEFIX 40-63	566252	40-63	black UV stabilized		17,6	40,5	280	5,9	360	100	600
ELEFIX 16-32	566248	16-32	white	GW 960° C	17,6	24,5	180	5,9	360	100	1200
ELEFIX 40-63	566253	40-63	white	GW 960° C	17,6	40,5	280	5,9	360	100	600

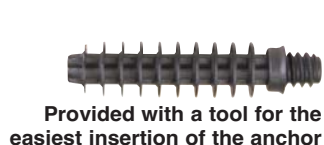

anchor M6/7

Type	Code	Anchor length (mm)	Ø Plug (mm)	Min drill depth (mm)	Thread	Packaging	
						Box	Carton
M6/7	566112	37	8	41	M6/7	100	1600



anchor UCX VM6

Type	Code	Anchor length (mm)	Ø Plug (mm)	Min drill depth (mm)	Thread	Packaging	
						Box	Carton
UCX 6x35 VM6	8710017	35	6	45	M6	100	3.200



anchor T6/VA6-8

Type	Code	Anchor length (mm)	Ø Plug (mm)	Min drill depth (mm)	Dimensions screw (mm)	Packaging	
						Box	Carton
T6/VA6	565390	30	6	40	4,5x40	100	1.600
T6/VA8	565391	40	8	50	5,0x50	50	800



self-drilling MINI DRIVA SCREW

Type	Code	Anchor Length (mm)	Head screw size (mm)	Packaging	
				Box	Carton
MINI DRIVA	565398	26,5	7,5	200	1600



self-drilling anchor T-CLICK

Type	Code	Anchor length (mm)	Head plug size (mm)	Dimension screw (mm)	Head screw size (mm)	Packaging	
						Box	Carton
T-CLICK	566301	38	14	4,5x45	10	100	800



self-drilling anchor DRIVA

Type	Code	Anchor length (mm)	Head plug size (mm)	Dimension screw (mm)	Head screw size (mm)	Packaging	
						Box	Carton
DRIVA	8704226	31	13	4,5x35	9,2	100	3200



self-drilling anchor DRIVA NYLON

Type	Code	Anchor length (mm)	Head plug size (mm)	Dimension screw (mm)	Head screw size (mm)	Packaging	
						Box	Carton
DRIVA NYLON	8704216	30	9,5	3,0x25	8,6	200	1600

ECAV



ECAV

ECAV is a plastic clip with an upper part suitable for pipes saddle measuring from Ø 4 to 60 mm.

ECAV can be installed with a light-weight anchor.

The characteristics are:

- Made of polypropylene colour grey RAL 7035.
- Flammability rating: UL 94-HB.
- Simple interlocking of the upper part by pressure.
- The pressure of the inside flexible tabs fix the pipes in position, leaving room for longitudinal movements.
- A side hook for connecting other pipe saddles in series.

ECAV is available in many diameters and packagings (box or industrial carton).

Type	Code	Min pipe diameter dc/min	Max pipe diameter dc/max	Resistance of the top part opening daN	Box pcs	Carton pcs
ECAV 8	13501008	4	8	10	200	1.200
ECAV 12	13501012	8	12	10	100	1.000
ECAV 16	13501016	12	16	23	75	750
ECAV 20	13501020	16	23	20	50	500
ECAV 25	13501025	20	25	25	50	500
ECAV 32	13501032	25	32	31	25	250
ECAV 40	13501040	32	40	40	20	200
ECAV 50	13501050	40	60	50	15	150

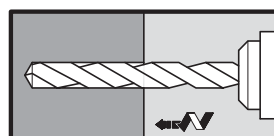
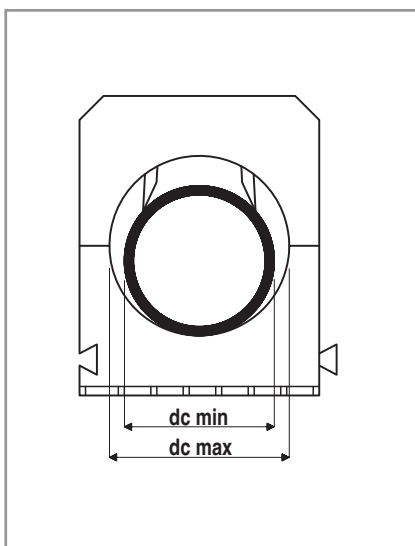

a

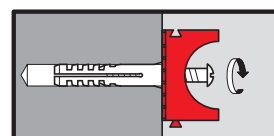

b

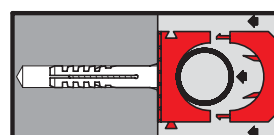

c

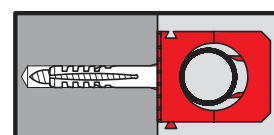

d

ECLIP



ECLIP

ECLIP is a plastic clip for fixing or protecting rigid, metric insulating pipes in electrical installations, on vertical or horizontal surfaces (from Ø 16 to 50 mm).

ECLIP can be installed with a light-weight anchor.

The characteristics are:

- Made of polypropylene colour grey RAL 7035.
- Flammability rating: UL 94-HB.
- A rounded shape to facilitate pipe accommodation.
- An elongated hole for adjusting wall fixings.
- A side hook for connecting other pipe clamps in series.
- A guide for laying in raceways.

ECLIP allows a fast, economic and precise fixing of plastic pipes in the electrical applications.

ECLIP is available in many diameters and packagings (box or industrial carton).

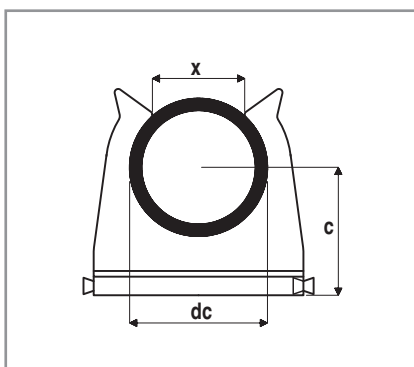

Type	Code	Pipe diameter (mm)	dc/(mm)	x/(mm)	c/(mm)	Width s/(mm)	Box pcs	Carton pcs
ECLIP 16	13502116	16	15	10,5	17,5	16	100	1.000
ECLIP 20	13502120	20	19	12,5	19,5	16	100	1.200
ECLIP 25	13502125	25	24	15,0	11,0	16	100	1.200
ECLIP 32	13502132	32	30	20,2	26,5	16	50	600
ECLIP 40	13502140	40	38	25,0	30,4	16	50	600
ECLIP 50	13502150	50	48	32,5	35,4	16	20	200

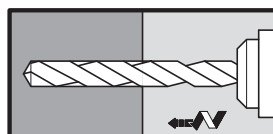

a

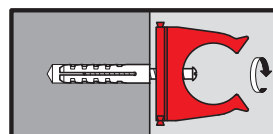

b

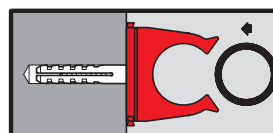

c

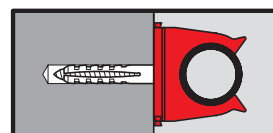

d

EBAN

EBAN

Metallic perforated banding for fixing PVC downpipes, parallel conducts and suspended installations.

EBAN is available in 3 widths, 2 thicknesses and in three different materials: zinc-plated steel, stainless steel and copper.

The banding has stamped holes that can be fixed with M4, M6, M8 thread or with an anchor.



Packed in box		Dimensions width x thickness	Ø Internal diameter	Ø Hole dimension	Q.ty roll
Type	Code	(mm)	(mm)	(mm)	mt
Zinc-plated steel	8412001	12 x 0,8	4,95	16	10
Zinc-plated steel	8412002	17 x 0,8	6,95	20	10
Zinc-plated steel	8412003	26 x 1,0	7,95	25	10
Stainless steel	8412102	17 x 0,8	6,95	20	10
Copper	8412011	12 x 0,8	4,95	16	10

TEXTILE BAND

TEXTILE BAND

The textile band, made of polypropylene, is suitable for floor fixings. This product is available in a packaging of 10 rolls of 10 meters each.



		Dimensions	Q.ty box
Description	Code	(mm)	pcs
Textile band in rolls of 10 mt	8412120	15x0,8	10 rolls

MANUAL NAIL SETTING TOOL

Impact nail setting tool for fixing conduit clips to concrete. Ergonomic handle. Simple and quick installation without pre-drilling.



		Q.ty box
Description	Code	pcs
manual setting tool	8412123	1

Steel nail for fixing conduit clips to concrete, without pre-drilling.



		Q.ty box
Description	Code	pcs
Steel nail - 18 mm. length	8412122	200

ACCESSORIES FOR FIXING

Applications

Bundle of cables.

Working temp.: -10°C÷85°C.

Flammable rate: UL 94-V2.

Characteristics

Material: polyamide 6.6 natural and black.
(characteristics on page 19)

Benefits

Easily releasable and reusable product.



TWIST LOCK

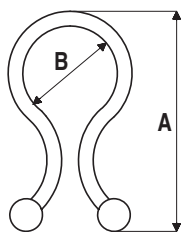

Code	Code	A	B	Bag	Carton
Natural	Black	(mm)	(mm)	pcs	pcs
1043105	1043106	22,9	5,1 - 7,6	1.000	25.000
1043108	1043109	26,2	7,6 - 10,2	1.000	20.000
1043111	1043112	30,5	10,2 - 12,7	1.000	15.000
1043113	1043114	34,5	13,5 - 16,0	1.000	10.000
1043115	1043116	39,4	17,8 - 20,3	1.000	6.000

Applications

Adhesive cable clamps for round cables.

Working temp.: -40°C÷85°C.

Flammable rate: UL 94-V2.

Characteristics

Material: PA 6.6
(characteristics on page 19)

Self adhesive bases with 2 different types of adhesive foam: rubber base, acrylic base.

The rubber base adhesives: are particularly suitable for immediate applications.

The acrylic base adhesive: is instead more suitable for long period applications and where a good UV ray resistance is required.

Benefits

Safe mount of a round cable on the surface without a screw or bolt.

Easy and fast application thanks to the adhesive base.



CABLE CLAMPS WITH RUBBER BASE ADHESIVE FOR ROUND CABLES

Code	Code	Dimensions (mm)				Bag	Carton
Natural	Black	A	B	C	D=E	pcs	pcs
5430 RBE	5431 RBE	10	5	4,9	19	100	10.000
5432 RBE	5433 RBE	12,3	12	12	26	100	5.000
5436 RBE	5439 RBE	16	15	18	26	100	4.000

CABLE CLAMPS WITH ACRYLIC BASE ADHESIVE FOR ROUND CABLES

Code	Code	Dimensions (mm)				Bag	Carton
Natural	Black	A	B	C	D=E	pcs	pcs
5430 3MVE		10	5	4,9	19	100	10.000
5432 3MVE		12,3	12	12	26	100	5.000
5436 3MVE		16	15	18	26	100	4.000

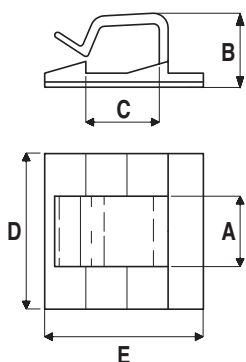

Applications

Adhesive cable clamps for flat cables.
 Working temp.: -10°C ÷ 70°C
 Flammability rating: UL 94-V0.

Characteristics

Material: PVC.
 (characteristics on page 19)
 Self adhesive bases with **rubber base adhesive**, that are particularly suitable for immediate applications.

Benefits

Safe mount of a flat cable on the surface without a screw or bolt.
 Easy and fast application thanks to the adhesive base.

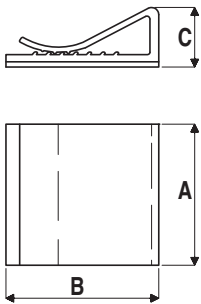

ADHESIVE FLAT RIBBON CABLE CLAMPS (PVC)

Code	Dimensions (mm)			Bag pcs	Carton pcs
	A	B	C		
Natural					
AFC-20	20	26	9,6	100	4.000
AFC-25	25	26	9,6	100	5.000
AFC-30	30	26	9,6	50	5.000

CRAMP WITH STEEL NAIL

Applications

Cramp with steel nail for round and flat cable.
 Working temp.: -40°C ÷ 100°C
 Flammability rating: UL-94 HB.

Characteristics

Material: HD Polyethylene with high thermic resistance. (characteristics on page 19).
 Nail in hardened and galvanized steel.

Benefits

The nail in steel allows an easy and fast installation in all solid surfaces.
 The practical rigid packaging allows the transport of the product without dispersion.

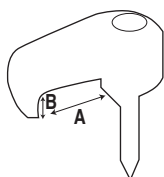

CRAMP WITH STEEL NAIL FOR FLAT CABLE - Box

Code	Code	Cramp dimension	Cable nr	Nail dimension	Carton
White	Grey	A x B (mm)	x section (mm ²)	(mm)	pcs
13620001	13630001	5,8x3,5	2x1	2x22	100
13620002	13630002	8x2	2x1,5-3x1	2x22	100
13620003	-	10x3,5	3x1,5-3x2,5	2x22	100



CRAMP WITH STEEL NAIL FOR ROUND CABLE - Box

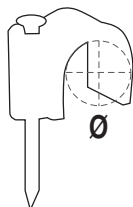

Code White	Code Grey	Cramp dimension Ø (mm)	Cable nr x section (mm ²)	Nail dimension (mm)	Carton pcs
13620004	13630004	4	1x1-2x0,5	2x20	100
13620005	13630005	5	2x0,75	2x22	100
13620006	13630006	6	2x1	2x22	100
13620007	13630007	7	2x1-2x1,5	2x27	100
13620008	13630008	8	2x2,5	2x27	100
13620009	13630009	9	3x2,5	2x27	100
13620010	13630010	10	2x4	2x30	100
13620012	13630012	12	3x6	2x35	100
13620014	13630014	14	4x6	2x35	100
13620017	13630017	17	3x10	2x40	50
13620018	-	6	TV antenna	2x30	100



CRAMP WITH STEEL NAIL FOR FLAT CABLE - Bag

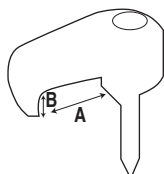

Code White	Code Grey	Cramp dimension A x B (mm)	Cable nr x section (mm ²)	Nail dimension (mm)	Carton pcs
13622001	13632001	5,8x3,5	2x1	2x22	100
13622002	13632002	8x2	2x1,5-3x1	2x22	100
13622003	13632003	10x3,5	3x1,5-3x2,5	2x22	100



CRAMP WITH STEEL NAIL FOR ROUND CABLE - Bag

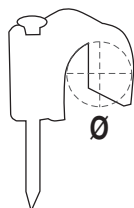

Code White	Code Grey	Cramp dimension Ø (mm)	Cable nr x section (mm ²)	Nail dimension (mm)	Carton pcs
13622004	13632004	4	1x1-2x0,5	2x20	100
13622005	13632005	5	2x0,75	2x22	100
13622006	13632006	6	2x1	2x22	100
13622007	13632007	7	2x1-2x1,5	2x27	100
13622008	13632008	8	2x2,5	2x27	100
13622009	13632009	9	3x2,5	2x27	100
13622010	13632010	10	2x4	2x30	100
13622012	13632012	12	3x6	2x35	100
13622014	13632014	14	4x6	2x35	100
13622017	13632017	17	3x10	2x40	50
13622018	-	6	TV antenna	2x30	100

CABLE PULLING DEVICE



Characteristics:

Elematic Cabling Systems offers an extensive range of duct rods made by fibreglass, polyester and nylon (Perlon) materials. It has a range of accessories and spare parts which enables the electricians the widest choice for their requirements. The new range ELETWIST in twisted polyester is offered into lengths from 10 to 30 m (diameter 4,5 mm), extendable with the dedicated accessory, while the nylon products range complete the selection with lengths from 10 to 25 meters and a 4 mm diameter. The range of fibreglass rods, with practical winders, offers products of length from 20 to 200 m, with diameters from 3 to 11 mm; All our duct rods are equipped with interchangeable terminals and can be used with a wide range of accessories, including the appropriate repair kit (fibreglass probes) that provide an easy and economic solution to the problem, allowing the continued work on site without wasting time.

HOW TO CHOOSE THE RIGHT DUCT ROD:

The main characteristics of the duct rods are their length and diameter.

FOR THE LENGTH: is recommended to choose a duct rod 3 to 5 meter longer than the duct in which you have to insert the cables.

FOR THE DIAMETER: it defines the pushing power and, at the same time, the maximum distance that can be reached in the duct.

Increasing the diameter size, the reachable distance rises, decreasing the turning radius curvature and enabling the easiest cable insertion. It means that it is very important to choose the right dimension, in order to get the maximum benefits of fibreglass material.

ADVISED USE

Type	∅ rod (mm)	∅ Pipes (mm)	Push energy	Introduction	Turns min. ∅ mm.	Break resistance (kg)	Pulling resistance with starting / ending junction (kg)	Life Time	Advised length (m)
Fibreglass	3	16-32	+++	+++	160	400	110	+	20-30
	4,5	40-60	+++	++	310	1200	170	++	50-80
	6	50-80	+++	++	400	2000	230	++	40-80
Fibreglass	9	63-125	+++	++	620	4400	340	++	60-120
	11	63-150	+++	++	770	6250	500	++	120-200
Twist	4,5	16-32	++	+++	100	250	130	+++	15-30
Nylon	4	20-25	+	+	100	520	115	--	10-25
Civil installations Industrial installation									

FIBREGLASS DUCT ROD "CABLE QUICK"



FIBREGLASS DUCT ROD "CABLE QUICK"

Code	Ø (mm)	Length (m)	Version	Box pcs
13550020	3	20	Standard	1
13550030	3	30	Standard	1
13551020	3	20	Plus*	1
13551030	3	30	Plus*	1

*Fully accessoried.

"CABLE QUICK" STANDARD - 20 mt Code 13550020

Type	Code	Cdt pcs
Spare-fiberglass rod ø 3 mm x 20 m	13560320	1
Starting terminals with eyelet and M5 thread	13570001	1
Flexible starting terminal ø 6 mm with eyelet and M5 thread	13570002	1
Pulling grip for ø 3-6 mm fiberglass rod	13570009	1
Foam lubricant	Free sample	1

"CABLE QUICK" PLUS - 20 mt Code 13551020

Type	Code	Cdt pcs
Spare-fiberglass rod ø 3 mm x 20 m	13560320	1
Starting terminal with eyelet and M5 thread	13570001	2
Flexible starting terminal ø 7 mm with eyelet and M5 thread	13570003	1
Flexible starting terminal ø 10 mm with eyelet and M5 thread	13570004	1
Starting/ending joint M5	13570005	2
Coupling joint	13570006	2
Cable Pulling grip M5 ø 4-6 mm	13570007	1
Special glue for rods	13570010	1
Pulling grip for ø 3-6 mm fiberglass rod	13570009	1
Foam lubricant	Free sample	1

"CABLE QUICK" STANDARD - 30 mt Code 13550030

Type	Code	Cdt pcs
Spare-fiberglass rod ø 3 mm x 30 m	13560330	1
Starting terminal with eyelet and M5 thread	13570001	1
Flexible starting terminal ø 6 mm with eyelet and M5 thread	13570002	1
Pulling grip for ø 3-6 mm fiberglass rod	13570009	1
Foam lubricant	Free sample	1

"CABLE QUICK" PLUS - 30 mt Code 13551030

Type	Code	Cdt pcs
Spare-fiberglass rod ø 3 mm x 30 m	13560330	1
Starting terminal with eyelet and M5 thread	13570001	2
Flexible starting terminal ø 7 mm with eyelet and M5 thread	13570003	1
Flexible starting terminal ø 10 mm with eyelet and M5 thread	13570004	1
Starting/ending joint M5	13570005	2
Coupling joint	13570006	2
Cable Pulling grip M5 ø 4-6 mm	13570007	1
Special glue for rods	13570010	1
Pulling grip for ø 3-6 mm fiberglass rod	13570009	1
Foam lubricant	Free sample	1

Applications

- Civil installations.

Characteristics

- Fibreglass Ø 3 mm and length till 30 mt.
- Ideal for ducts with diameter till 32 mm.
- Excellent boost power.
- Min. radius curvature: 160 mm.
- Pulling resistance (with starting and ending, terminals): 110 kg.
- Breaking strength: 400 kg.

Advantages

- Fast insertion.
- Easy wind up thanks to the practical pulling grip tool in shockproof material.
- Wide range of accessories (Plus version).
- Interchangeable thacaded M5 terminals.

VERSION STANDARD

VERSION PLUS

CABLE QUICK SPARE PARTS

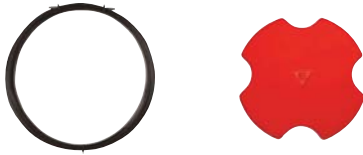

SPARE-FIBREGLASS ROD - PULLING/PUSHING GRIP

Code		Ø (mm)	Length (m)	Thread	Box pcs
13560320	Rod	3	20	M5	1
13560330	Rod	3	30	M5	1
13570009	Pulling for Ø 3-6 mm fibreglass rod				3

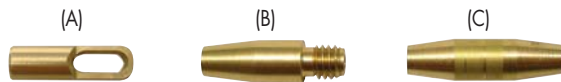

STARTING TERMINAL WITH EYELET -STARTING/ENDING JOINT - COUPLING

Code		Ø (mm)	Thread	Box pcs
13570001	Starting terminal (A)	6	M5	3
13570005	Starting/ending joint (B)		M5	3
13570006	Coupling joint (C)	3	-	3



FLEXIBLE STARTING TERMINAL M5

Code		Ø (mm)	Thread	Box pcs
13570002	(D)	6	M5	2
13570003	(E)	7	M5	2
13570004	(F)	10	M5	2



CABLE PULLING GRIP M5

Code		Ø Cable (mm)	Length (mm)	Thread	Box pcs
13570007		4-6	200	M5	1
13570008		6-9	210	M5	1



SPECIAL GLUE for rods - CABLE LUBRICANTS

Code		Weight (ml)	Box pcs
13570010	Special glue (*)	3	2
13520000	Lubricant foam (**)	400	1
13520001	Lubricant gel (**)	500	1

(*) Acrylic glue (cyanoacrylate) for repairing fibreglass duct rods.
 • Light viscosity and high resistance.
 • Colourless.
 • Re-closable and reusable small bottle.

(**) Lubricant foam/gel, water base, for favouring the passage of wires and cables in the electrical ducting; it reduces of 80% the friction in inserting the duct rods and wires on pipes.
 • The innovate formula avoids the glue effect, typical of many other products. After its fast evaporation, the component remains allowing the take off the wires even after a long period and a critical temperature as well.
 • Working and stocking temperature: -10° C ÷ 50°.
 • Chemical inert and non-toxic.

FIBREGLASS DUCT RODS Ø 4,5 ÷ 11 mm with cage

Applications

Tertiary and industrial installation.

Characteristics

- Self energetic fibreglass ø from 4,5 to 11 mm and length till 200 mt, complete with starting and ending terminals.
- High boost power.
- For more technical information, please see the table et page 47.

Avantages

- Fast insertion.
- Easy to wind up and to transport, thanks to the galvanized steel cage with brake on the hub and handhold.
- Interchangeable threaded terminals.
- Wide range of accessories.



FIBREGLASS DUCT RODS WITH STEEL CAGE

Code	Ø (mm)	Length (m)	Thread	Cage ø (mm)	Box pcs
13550450	4,5	50	M5	330	1
13550480	4,5	80	M5	330	1
13550640	6	40	M6	550	1
13550660	6	60	M6	550	1
13550680	6	80	M6	550	1
13550960	9	60	M12	630	1
13550912*	9	120	M12	1000	1
13551112*	11	120	M12	1000	1
13551115*	11	150	M12	1000	1
13551120*	11	200	M12	1000	1

* Wheeled version.

GLASS FIBRE ROD SPARE PARTS AND ACCESSORIES

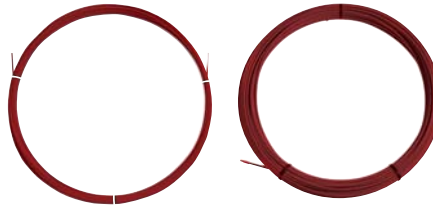

SPARE FIBRE GLASS ROD

Code	Ø (mm)	Length (m)	Thread	Box pcs
13560450	4,5	50	M5	1
13560480	4,5	80	M5	1
13560640	6	40	M6	1
13560660	6	60	M6	1
13560680	6	80	M6	1
13560960	9	60	M12	1
13560912	9	120	M12	1
13561112	11	120	M12	1



STARTING TERMINAL with hole

Code	Ø rod (mm)	Thread	Box pcs
13570011	4,5	M5	3
13570016	6	M6	1



STARTING TERMINAL made of light alloy with steel shackle

Code	Ø rod (mm)	Thread	Box pcs
13570012	4,5	M5	1
13570017	6	M6	1
13570021	9/11	M12	1



STARTING ROLLER made of light alloy

Code	Ø rod (mm)	Thread	Box pcs
13570013	4,5	M5	1
13570018	6	M6	1
13570022	9/11	M12	1



STARTING/ENDING THREADED JUNCTION for fiberglass rod

Code	Ø rod (mm)	Thread	Box pcs
13570014	4,5	M5	3
13570019	6	M6	1
13570023	9	M12	1
13570025	11	M12	1



COUPLING JOINT for repairing rods

Code	Ø rod (mm)	Box pcs
13570015	4,5	3
13570020	6	1
13570024	9	1
13570026	11	1



STEEL CABLE PULLING GRIP with 1 simple eyelet

Code	Ø cables (mm)	Length (mm)	Box pcs
13570027	12-15	460	1
13570028	15-19	500	1
13570029	19-25	520	1
13570030	25-31	580	1



STEEL CABLE PULLING GRIP 1250 mm, with 1-2 simple eyelets

Code	Ø cables (mm)	Length (mm)	Box pcs
13570031	15-20	1250	1
13570032	20-30	1250	1
13570033	30-40	1250	1
13570034	40-50	1250	1
13570035	15-20	1250	1
13570036	20-30	1250	1
13570037	30-40	1250	1
13570038	40-50	1250	1

SPECIAL GLUE for rods

Code	Nominal capacity (ml)	Box pcs
13570039	24	1

NYLON DUCT RODS 4 mm

Applications

- Tertiary and industrial installations.

Characteristics

- Nylon Perlon with \varnothing 4 mm and length till 25 mt.
- High flexibility.
- Pulling resistance (with starting and ending connections): 115 kg.
- For more technical information see the table et page 47.

Avantages

- Efficiency and practical usage.
- Ideal for short duct section.
- Interchangeable threaded M4 terminals.



NYLON DUCT RODS \varnothing 4 mm

Code	\varnothing (mm)	Length (m)	Tensile strength (kg)	Box pcs
13510210	4	10	115	1
13510215	4	15	115	1
13510220	4	20	115	1
13510225	4	25	115	1

* Other dimensions and types available on request.

Accessories



STARTING TERMINAL M4

Code	\varnothing (mm)	Thread	Box pcs
13510001	5	M4	3



FLEXIBLE STARTING TERMINAL M4

Code	\varnothing (mm)	Thread	Box pcs
13510002	5	M4	2

ELETWIST - POLYESTER DUCT RODS Ø 4,5mm

Applications

- Tertiary and industrial installations.

Characteristics

- Duct rod made in twisted polyester ø 4,5 from 10 to 30 meters, complete with starting and ending terminals;
- High boost power;
- Easy insertion;
- For more technical information, please see the table at page 47.

Avantages

- Power and flexibility;
- Provided with a pulling grip to make easier the traction;
- Interchangeable threaded M5 terminals
- Possibility to join two rods with the coupling joint.

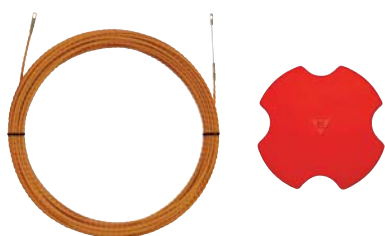

ELETWIST DUCT RODS ø 4,5 mm

Code	Ø (mm)	Length (m)	Tensile strength (kg)	Box pz.
13530410	4,5	10	130	1
13530415	4,5	15	130	1
13530420	4,5	20	130	1
13530425	4,5	25	130	1
13530430	4,5	30	130	1

Accessories



STARTING TERMINAL M5

Code	Ø (mm)	Thread	Box pz.
13530001	5	M5	3



FLEXIBLE STARTING TERMINAL M5

Code	Ø (mm)	Thread	Box pz.
13530002	5	M5	2



COUPLING JOINT THREADED M5

Code	Ø (mm)	Thread	Box pz.
13530003	5	M5	3



STEEL CAGE FOR ELETWIST ø 4,5 mm

Code	Ø (mm)	Ø cage (mm)	Box pz.
13530004	5	280	1