



SON4 - 10 Tone Sounder & L.E.D. Beacon 'Sonora'



SON4 L.E.D

INSTALLATION INSTRUCTIONS

12,24,48vdc

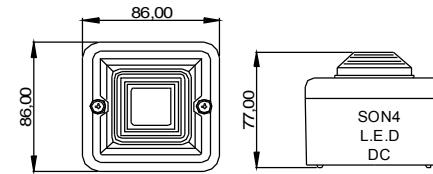
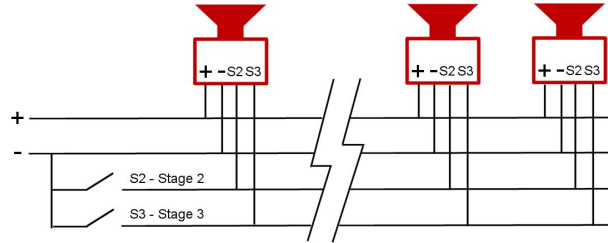
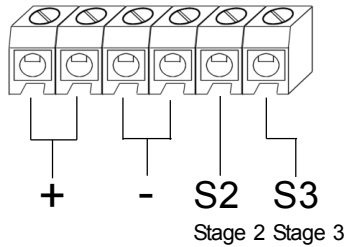

24,115, 230vac

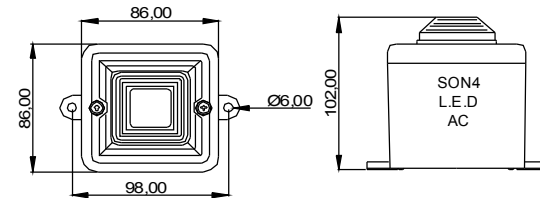
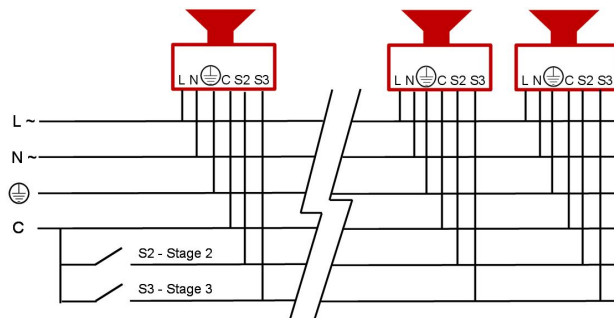
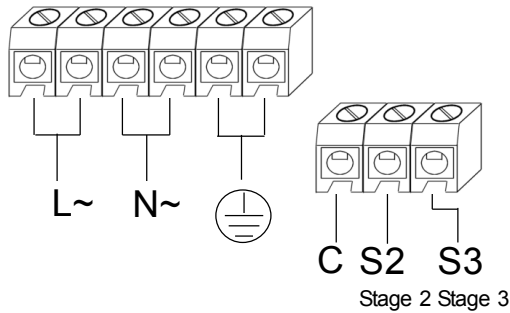

Voltage :	12vdc	24vdc	48vdc	24vac	115vac	230vac
				50/60Hz	50/60Hz	50/60Hz

Voltage range :	+/-25%	+/-25%	+/-25%	+/-10%	+/-10%	+/-10%
-----------------	--------	--------	--------	--------	--------	--------

Current mA :	50mA	35mA*	40mA	60mA	25mA	20mA
--------------	------	-------	------	------	------	------

* Current at nominal voltage on Tone 1.

>100dB(A)@1m



ISN0606-B

No liability is accepted for any consequence of the use of this document. The technical specification of this unit is subject to change without notice due to our policy of continual product development. All dimensions are approximate. This unit is sold subject to our standard conditions of sale, a copy of which is available on request.

SON4L 24vdc unit is CPD Compliant. EN54-3 Type B IP55

Stage1 tone	Frequency Description	The tones listed have been tested to EN54-3 and are compliant with the Construction Product Directive 89/106/EEC.
Tone 1	800/1000Hz @ 0.25 sec Alternating	EN54-3 test data: document D0665
Tone 2	500/1200Hz @ 0.3Hz 0.5 sec Slow Whoop	
Tone 3	1200/500Hz @ 1Hz - DIN / PFEER P.T.A.P.	
Tone 4	544Hz (100mS)/440Hz (400mS) - NF S 32-001	
Tone 5	1000Hz Continuous	
Tone 6	2400/2900 @ 50Hz sw eeping	
Tone 7		
Tone 8		

Stage1 tone	Frequency Description		Stage2 (S2)	Stage3 (S3)
Tone 1	800/1000Hz @ 0.25 sec Alternating		Tone 8	Tone 5
Tone 2	500/1200Hz @ 0.3Hz 0.5 sec Slow Whoop		Tone 1	Tone 8
Tone 3	1200/500Hz @ 1Hz - DIN / PFEER P.T.A.P.		Tone 1	Tone 8
Tone 4	544Hz (100mS)/440Hz (400mS) - NF S 32-001		554Hz	Tone 2
Tone 5	1000Hz Continuous - PFEER Toxic Gas		Tone 1	Tone 6
Tone 6	Bell		Tone 1	Tone 8
Tone 7	800/1000Hz @ 7Hz Sweeping		Tone 5	Tone 1
Tone 8	2400/2900Hz @ 50Hz Sweeping		Tone 5	Tone 1
Tone 9	420Hz @ 0.625 sec Australian Alert		Tone 10	Tone 5
Tone 10	500-1200Hz 3.75sec /0.25sec. Australian Evac.		Tone 6	Tone 5

Fig 1.

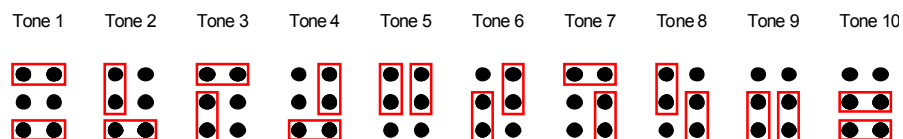

- **Tone selection.** To select a tone place the pin link in the position shown above (Fig. 1).
- **Sélection de la tonalité / réglage des commutateurs.** Pour sélectionner une tonalité, mettre les socles à broches dans les positions illustrées (Fig. 1).
- **Tonwahl / Einstellung der Schalter.** Zur Wahl eines Tons die Klemmenanschlüsse in die angegebenen Positionen bringen (Fig. 1).
- **Selezione tono / regolazione commutatore.** Per selezionare un tono, disporre i collegamenti a cavallotto nelle posizioni indicate (Fig. 1).
- **Seleção de tons / ajuste dos comutadores.** Para seleccionar um tom, coloque as ligações dos pinos na posição mostrada (Fig.1).
- **Selección Tono / programación interruptores.** Para seleccionar un tono colocar las conexiones de los puentes en las posiciones mostradas (Fig. 1).
- **Toonselectie.** Om een toon te selecteren de pinverbinding in de hierboven aangetoonde positie plaatsen (Fig. 1)
- **Valg af tone.** Valg af en tone sker ved at anbringe stiftforbindelsen i ovenstående position (fig.1).
- **Velge tone.** For å velge en tone må du plassere stiftledet i posisjonen som vist ovenfor (fig. 1).
- **Tonval.** Välj en ton genom att placera stiftanslutningen i läget som visas ovan (fig. 1).

NOTE: Please check factory settings and ensure the correct alarm tone is selected for your country or application.

Pas op: bij ingebruikstelling dient u zich ervan te overtuigen dat de unit op de juiste toon is ingesteld.



- Volume Control
- Réglage du volume
- Steuerung der Lautstärke
- Controllo volume
- Controlo do Volume
- Control Volumen
- Volumen kontrol
- Volum eregeling
- Volum kontroll
- Volyrn kontroll