

BExS110D-SIL

### 1) Warnings



DO NOT OPEN WHEN AN EXPLOSIVE ATMOSPHERE IS PRESENT  
DO NOT OPEN WHEN ENERGIZED  
POTENTIAL ELECTROSTATIC CHARGING HAZARD  
COVER BOLTS CLASS A4-80  
USE HEAT RESISTING CABLES AND CABLE GLANDS (RATED 110°C) AT AMB. TEMPERATURES OVER 40°C

The units can be installed in locations with the following conditions:

#### Area Classification Gas:

Zone 1	Explosive gas air mixture likely to occur in normal operation.
Zone 2	Explosive gas atmosphere not likely to occur in normal operation but may be present for short periods.

#### Gas Groupings:

Group IIA	Propane
Group IIB	Ethylene
Group IIC	Hydrogen and Acetylene (up to 55°C ambient)

#### Temperature Classification:

T1	450°C
T2	300°C
T3	200°C
T4	135°C

#### Area Classification Dust:

Zone 21	Explosive dust air mixture likely to occur in normal operation.
Zone 22	Explosive dust air mixture not likely to occur in normal operation, and if it does, it will only exist for a short time.

#### Dust Groupings:

Group IIIA	Combustible Dusts
Group IIIB	Non-Conductive Dust
Group IIIC	Conductive Dust

#### Maximum Surface Temperature for Dust Applications:

100°C at +55 °C ambient  
115 °C at +70 °C ambient

**IP Rating:** IP66/67 to EN/IEC60529 and IP6X to EN/IEC60079-0, EN/IEC60079-31

**Equipment Category:** 2G / 2D

**Equipment Protection Level:** Gb / Db

#### Ambient Temperature Range:

-50°C to +55°C Gas Groups IIA, IIB and IIC  
-50°C to +70°C Gas Groups IIA and IIB  
-50°C to +70°C Dust Groups IIIA, IIIB and IIIC

SIL 2 Unit operating temperature range -25°C to +60°C

### 2) Rating & Marking Information

All units have a rating label, which carries the following important information:-

**Model No.:** BExS110D-SIL

**Input Voltage:** DC Units 24V

#### BExS110D-SIL:

Ex d IIC T4 Gb Ta. -50°C to +55°C  
Ex d IIB T4 Gb Ta. -50°C to +70°C  
Ex tb IIIC T100°C Db Ta. -50°C to +55°C  
Ex tb IIIC T115°C Db Ta. -50°C to +70°C

**Certificate No.** KEMA 99ATEX6312X  
IECEX KEM 10.0003X

Epsilon x  
Equipment Group and  
Category:

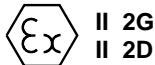

CE Marking  
Notified Body No.

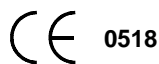

### 3) Type Approval Standards

The sounder carries an EC Type Examination Certificate and IECEx Certificate of Conformity, and have been certified to comply with the following standards:

EN60079-0:2012+A11:2013 / IEC60079-0:2011 (Ed 6):  
Explosive Atmospheres - Equipment. General requirements

EN60079-1:2007 / IEC60079-1:2007 (Ed 6):  
Explosive Atmospheres - Equipment protection by flameproof enclosures "d"

EN 60079-31:2014 / IEC60079-31:2013 (Ed 2):  
Explosive Atmospheres - Equipment dust ignition protection by enclosure "t"

### 4) Installation Requirements

The sounder must only be installed by suitably qualified personnel in accordance with the latest issues of the relevant standards:

EN60079-14 / IEC60079-14: Explosive atmospheres -  
Electrical installations design, selection and erection

EN60079-10-1 / IEC60079-10-1: Explosive atmospheres -  
Classification of areas. Explosive gas atmospheres

EN60079-10-2 / IEC60079-10-2: Explosive atmospheres -  
Classification of areas. Explosive dust atmospheres

The installation of the sounder must also be in accordance with any local codes that may apply and should only be carried out by a competent electrical engineer who has the necessary training.

### 5) Special Conditions of Use

Repair of the flamepath / flameproof joints is not permitted.

The enclosure is non-conducting and may generate an ignition-capable level of electrostatic charges under certain extreme conditions (such as high-pressure steam). The user should ensure that the equipment is not installed in a location where it may be subjected to external conditions that might cause a build-up of electrostatic charges on non-conducting surfaces.

Additionally, cleaning of the equipment should be done only with a damp cloth.

### 6) Location and Mounting

The location of the sounder should be made with due regard to the area over which the warning signal must be visible. They should only be fixed to services that can carry the weight of the unit.

The BEx sounder should be secured to any flat surface using the three 7mm fixing holes on the stainless steel U shaped mounting bracket. See Figure 1. The required angle can be achieved by loosening the two large bracket screws in the side of the unit, which allow adjustment of the side of the sounder in steps of 18°. On completion of the installation then two large bracket adjustment screws on the side of the unit must be fully tightened to ensure that the unit cannot move in service.

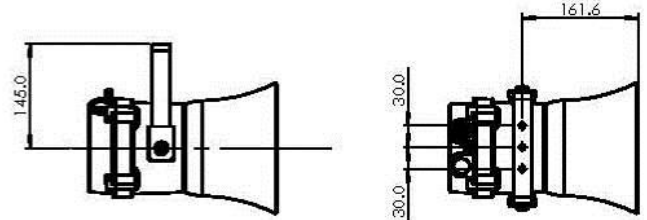

Fig. 1 Fixing Location for S110 Sounder

### 7) Access to the Flameproof Enclosure



Warning – High voltage may be present, risk of electric shock. DO NOT open when energised, disconnect power before opening.



Warning – Hot surfaces. External surfaces and internal components may be hot after operation, take care when handling the equipment.

To access the Ex d chamber, remove the four M6 hexagon socket head screws and withdraw the flameproof cover taking extreme care not to damage the flameproof joints in the process. M6 cover screws are Class A4-80 stainless steel and only screws of this category can be used for the enclosure.

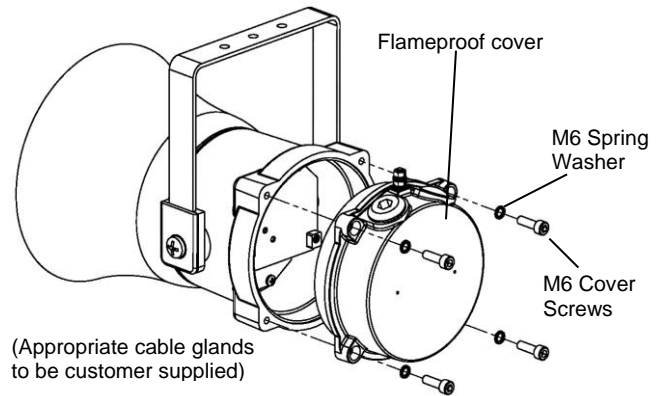

Fig. 2 Accessing the Explosion proof Enclosure.

On completion of the installation, the flameproof joints should be inspected to ensure that they are clean and that they have not been damaged during installation.

Check that the earth bonding wire between the two castings is secure and the 'O' ring seal is in place. When replacing the flameproof cover casting ensure that it is square with the flameproof chamber casting before inserting. Carefully push the cover in place allowing time for the air to be expelled. Only after the cover is fully in place should the four M6 Stainless Steel A4-80 cover bolts and their spring washer be inserted and tightened down. If the cover jams while it is being inserted, carefully remove it and try again. Never use the cover bolts to force the cover into position.

## 8) Power Supply Selection

It is important that a suitable power supply is used to run the equipment. The power supply selected must have the necessary capacity to provide the input current to all of the units.

The following table shows the input current taken by the various sounders and shows the maximum voltage at which the sounders can be operated:

Model No.	Nominal I/P Voltage	Input Current	Voltage Range
BExS110D-SIL	24Vdc	290mA	20-28V

The input current will vary according to the voltage input level and the frequency of the tone selected. The current levels shown above are for the 440Hz Continuous tone @ nominal input voltage.

## 9) Selection of Cable, Cable Glands, Blanking Elements & Adapters

When selecting the cable size, consideration must be given to the input current that each unit draws (see table above), the number of sounders on the line and the length of the cable runs. The cable size selected must have the necessary capacity to provide the input current to all of the sounders connected to the line.

For ambient temperatures over +40°C the cable entry temperature may exceed +70°C and therefore suitable heat resisting cables and cable glands must be used, with a rated service temperature of at least 110°C

The dual cable gland entries have an M20 x 1.5 entry thread. To maintain the ingress protection rating and mode of protection, the cable entries must be fitted with suitably rated ATEX / IECEx certified cable glands and/or suitably rated ATEX / IECEx certified blanking devices during installation according to EN / IEC60079-14.

If a high IP (Ingress Protection) rating is required then a suitable sealing washer must be fitted under the cable glands or blanking plugs.

For use in explosive dust atmospheres, a minimum ingress protection rating of IP6X must be maintained.

The BEx sounder range can be supplied with the following types of adapters:

M20 to ½" NPT  
M20 to ¾" NPT  
M20 to M25

It is important to note that stopping plugs cannot be fitted onto adapters, only directly onto the M20 entries. Any other adapters used must be suitably rated and ATEX / IECEx certified adapters.

## 10) Earthing

Both AC and DC sounder units must be connected to an earth. The units are provided with internal and external earth terminals which are both located on the terminal chamber section of the unit.

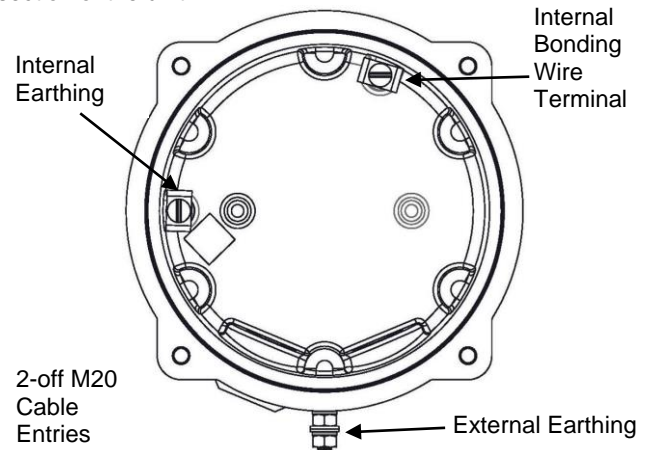

Fig. 3 Internal View of Cover

When using the internal earth terminal ensure that the stainless steel M4 flat washer is between the incoming earth wire and the enclosure.

Internal earthing connections should be made to the Internal Earth terminal in the base of the housing using a ring crimp terminal to secure the earth conductor under the earth clamp. The earth conductor should be at least equal in size and rating to the incoming power conductors.

External earthing connections should be made to the M5 earth stud, using a ring crimp terminal to secure the earth conductor to the earth stud. The external earth conductor should be at least 4mm<sup>2</sup> in size.

## 11) Cable Connections

Electrical connections are to be made into the terminal blocks on the PCBA located in the flameproof enclosure. See section 7 of this manual for access to the flameproof enclosure.

Wires having a cross sectional area between 0.5 mm<sup>2</sup> to 2.5mm<sup>2</sup> can be connected to each terminal way. If an input and output wire is required the 2-off Live/Neutral or +/- terminals can be used. If fitting 2-off wires to one terminal way the sum of the 2-off wires must be a maximum cross sectional area of 2.5mm<sup>2</sup>. Strip wires to 8mm. Wires may also be fitted using ferrules. Terminal screws need to be tightened down with a tightening torque of 0.45 Nm / 5 Lb-in. When connecting wires to the terminals great care should be taken to dress the wires so that when the cover is inserted into the chamber the wires do not exert excess pressure on the terminal blocks. This is particularly important when using cables with large cross sectional areas such as 2.5mm<sup>2</sup>.

## 12) S110 DC Wiring

A 4-way terminal block is provided on the DC Sounder. There are 1-off +ve, 1-off -ve, 1-off stage 2 and 1-off stage 3 terminals in total.

### 12.1 Wiring Diagrams

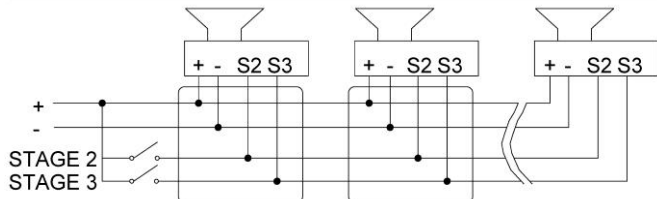

Fig. 4a DC Simplified Block Diagram (Positive switching)

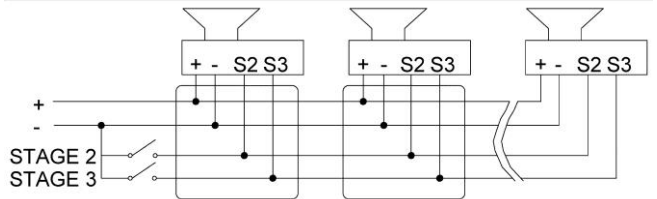
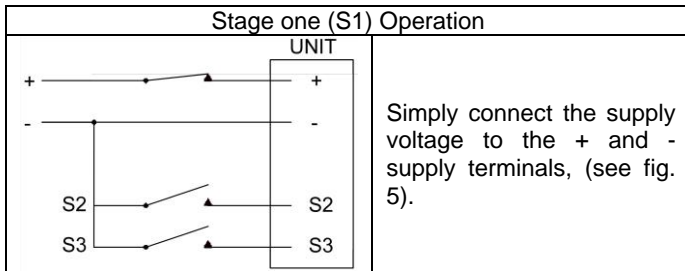

Fig. 4b DC Simplified Block Diagram (Negative switching)

### 12.2 Stage Switching

#### 12.2.1 Units First Stage Tones



#### 12.2.2 DC Units Second & Third Stage Tone Selection

For units set up for -ve switching (default setting):

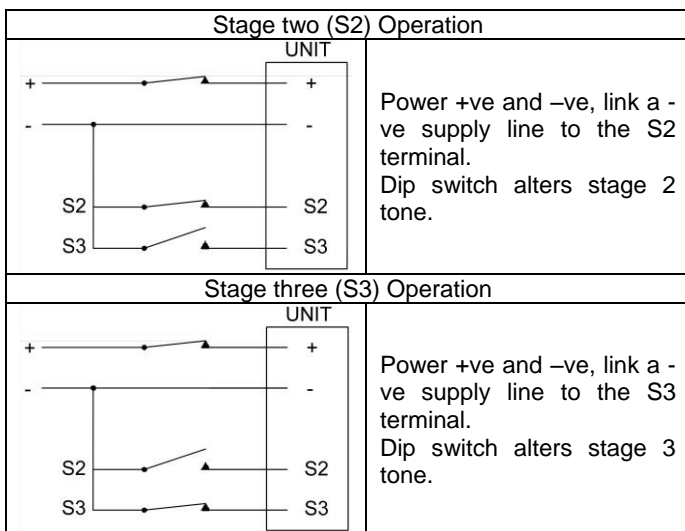

For units set up for +ve switching (refer to 13.3):

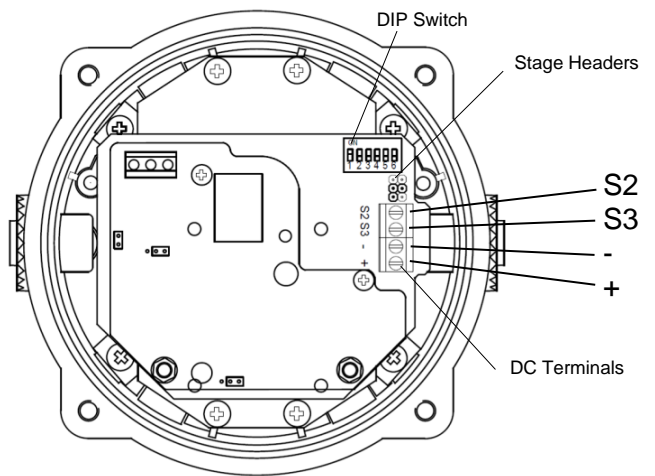
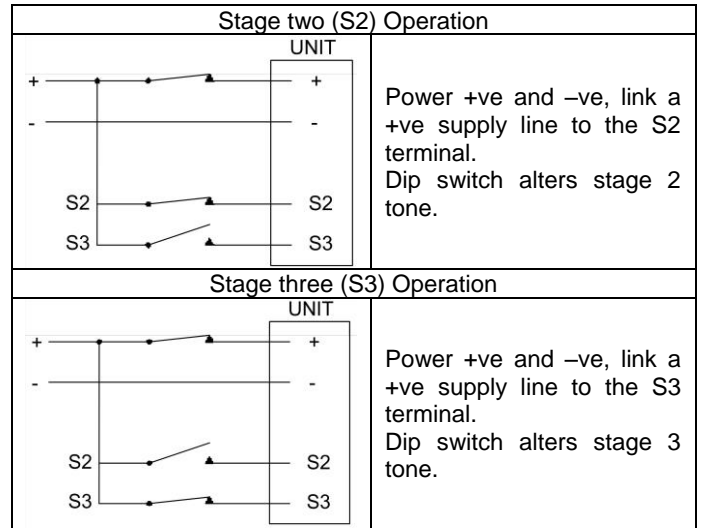

Fig. 5 S110 DC Terminals

### 12.3 S110 Stage Switching Polarity (DC Units Only)

The BExS110D DC sounders have the facility to use either +ve or -ve switching to change the tone to the second and third stages. Negative switching is the default setting. For -ve switching connect the two headers on the pcb to the left-hand (marked -ve) and centre pins. For +ve switching connect the headers to the right hand (marked +ve) and the centre pins. (Refer to Fig. 6)

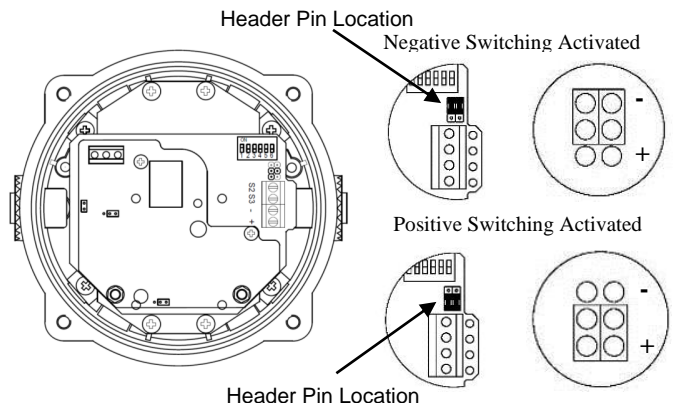

Fig. 6 Stage Switching Polarity

### 13) Volume Control (None)

BExS110D-SIL sounder have no volume control, as the unit is monitoring its output the volume cannot be adjusted.

#### SIL 2 APPROVED TONE SELECTION TABLE

BExS110D-SIL sounders need to be set to one off the SIL 2 approved tones to work correctly with the automated sounder check on pattern generation and signal output checks

**Important:** - Only tones 1, 2, 11, 19 and 31 are approved for use in the SIL 2 application. Ensure that the unit is set to one of these tones. As factory default the sounder should be set to Tone 1.

Tone Selection		DIP Switch Settings	Stage Selection	
Stage 1	Frequency Description	1 2 3 4 5	Stage 2	Stage 3
1	Continuous 1000Hz Toxic Gas Alarm	0 0 0 0 0	Tone 31	Tone 11
2	Alternating 800/1000Hz at 0.25s intervals	1 0 0 0 0	Tone 17 (NOT SIL Approved)	Tone 5 (NOT SIL Approved)
11	Intermittent 1000Hz at 0.5Hz General alarm	0 1 0 1 0	Tone 31	Tone 1
19	1400Hz to 1600Hz sweep up over 1s - 1600Hz to 1400Hz sweep down over 0.5s	0 1 0 0 1	Tone 2	Tone 5 (NOT SIL Approved)
31	1200/500Hz at 1 Hz Prepare to Abandon Platform	0 1 1 1 1	Tone 11	Tone 1

#### GENERAL TONE SELECTION TABLE

Note not all of these tones are approved to work in a SIL 2 configuration, see the SIL 2 Approved tone selection table for these.

Tone Selection		DIP Switch Settings					Stage Selection	
Stage 1	Frequency Description	1	2	3	4	5	Stage 2	Stage 3
1	Continuous 1000Hz <b>Toxic Gas Alarm</b>	0	0	0	0	0	Tone 31	Tone 11
2	Alternating 800/1000Hz at 0.25s intervals	1	0	0	0	0	Tone 17	Tone 5
3	Slow Whoop 500/1200Hz at 0.3Hz with 0.5s gap repeated	0	1	0	0	0	Tone 2	Tone 5
4	Sweeping 800/1000 at 1Hz	1	1	0	0	0	Tone 6	Tone 5
5	Continuous at 2400Hz	0	0	1	0	0	Tone 3	Tone 27
6	Sweeping 2400/2900Hz at 7Hz	1	0	1	0	0	Tone 7	Tone 5
7	Sweeping 2400/2900Hz at 1Hz	0	1	1	0	0	Tone 10	Tone 5
8	Siren 500/1200/500Hz at 0.3Hz	1	1	1	0	0	Tone 2	Tone 5
9	Sawtooth 1200/500Hz at 1Hz	0	0	0	1	0	Tone 15	Tone 2
10	Alternating 2400/2900Hz at 2Hz	1	0	0	1	0	Tone 7	Tone 5
11	Intermittent 1000Hz at 0.5Hz <b>General alarm</b>	0	1	0	1	0	Tone 31	Tone 1
12	Alternating 800/1000Hz at 0.875Hz	1	1	0	1	0	Tone 4	Tone 5
13	Intermittent 2400Hz at 1Hz	0	0	1	1	0	Tone 15	Tone 5
14	Intermittent 800Hz 0.25s on 1s off	1	0	1	1	0	Tone 4	Tone 5
15	Continuous at 800Hz	0	1	1	1	0	Tone 2	Tone 5
16	Intermittent 660Hz 150mS on, 150mS off	1	1	1	1	0	Tone 18	Tone 5
17	Alternating 544Hz (100mS)/440Hz(400mS)	0	0	0	0	1	Tone 2	Tone 27
18	Intermittent 660Hz 1.8s on, 1.8s off	1	0	0	0	1	Tone 2	Tone 5
19	1400Hz to 1600Hz sweep up over 1s - 1600Hz to 1400Hz sweep down over 0.5s	0	1	0	0	1	Tone 2	Tone 5
20	Continuous 660Hz	1	1	0	0	1	Tone 2	Tone 5
21	Alternating 554/440Hz at 1Hz	0	0	1	0	1	Tone 2	Tone 5
22	Intermittent 554Hz at 0.875Hz	1	0	1	0	1	Tone 2	Tone 5
23	800Hz pulsing at 2Hz	0	1	1	0	1	Tone 6	Tone 5
24	Sweeping 800/1000Hz at 50Hz	1	1	1	0	1	Tone 29	Tone 5
25	Sweeping 2400/2900Hz at 50Hz	0	0	0	1	1	Tone 29	Tone 5
26	Simulated bell sound	1	0	0	1	1	Tone 2	Tone 1
27	Continuous 554Hz	0	1	0	1	1	Tone 26	Tone 5
28	Continuous 440Hz	1	1	0	1	1	Tone 2	Tone 5
29	Sweeping 800/1000Hz at 7Hz	0	0	1	1	1	Tone 7	Tone 5
30	420Hz repeating 0.625s on, 0.625s off <b>Australian alert signal</b>	1	0	1	1	1	Tone 32	Tone 5
31	1200/500Hz at 1 Hz <b>Prepare to Abandon Platform</b>	0	1	1	1	1	Tone 11	Tone 1
32	Sweeping 500/1200Hz 3.75s on, 0.25s off 15Hz	1	1	1	1	1	Tone 26	Tone 1

## 14) SIL 2 Instruction/Safety Manual

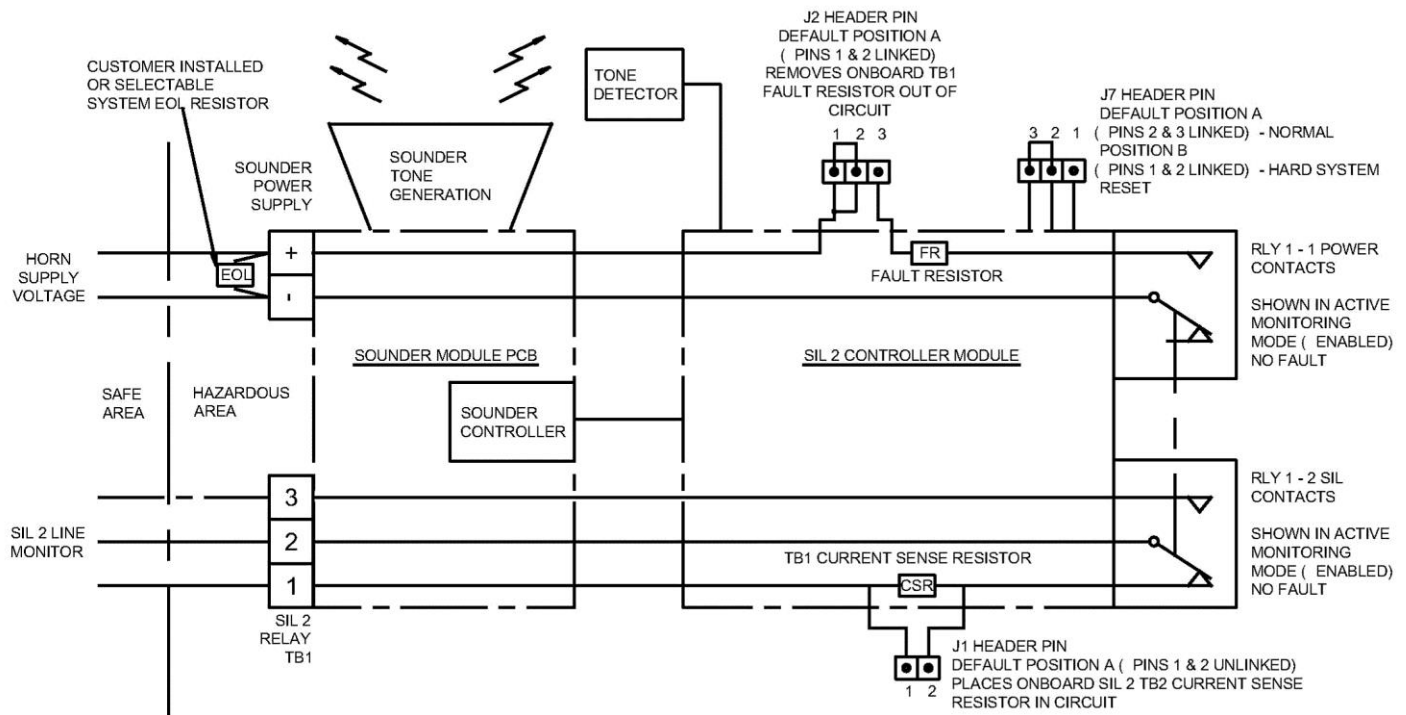

Figure 7 - The SIL 2 Module monitors the Sounder and interfaces to the customer plant.

**Warning** – To maintain the integrity of the SIL 2 units the system must be installed in accordance with this manual. Any deviation could result in failure of the SIL 2 system and an unintended unit operation or function.

**Warning** – Unit must be installed, commissioned and used within the parameters outlined in this manual. Failure to comply with this will result in potential unit failure within the system.

**Warning** – The unit must be powered in either Standby or Active modes to comply with the SIL 2 approval requirement.

**Warning** – If the power is disrupted the unit must be allowed to go through the commissioning cycle to reset, if this does not happen and the power continues to be disrupted the unit will latch the fault and require a hard system reset.

**Warning** – Only SIL 2 approval tones can be used to comply with the SIL 2 approval requirement. See SIL approved tone selection table in section 15.

### SIL 2 System Description

The E2S BEx range of IECEx & ATEX compliant signaling devices with integrated SIL 2 fault monitoring modules.

The SIL 2 module monitors the function of the device and provides feedback to the control panel. A fault condition can be communicated via independent fault contacts or by the introduction to the monitoring circuit of an end of line resistor. A SIL 2 system wiring for fault detection in standby and active mode – 4 wire installation can be seen as per section 18.1. A SIL 2 system wiring for fault detection in standby and active mode – 2 wire installation can be seen as per section 18.2.

The new SIL 2 version of the E2S BExS110-SIL alarm horn sounder and BExBG05-SIL, BExBG10-SIL & BExBG15-SIL Xenon strobe beacon are designed, tested and certified, bringing plant safety to new levels.

#### Key benefits:

- Signaling device function is checked and automatically reported to the control panel.
- Eliminates the need for time consuming physical inspections.
- Increased plant safety, confidence that all devices are fully functioning.

- Designed to integrate seamlessly into your SIL 2 environment.

## 15) SIL 2 System Terms and Function

The SIL 2 Sounder Unit Monitors

- Standby mode and Active mode
- Health status of power supply
- Sounder correct function and tone pattern

The SIL 2 sounder operates as part of a SIL 2 system.

The sounder will after commissioning remain powered in **Standby mode** (reverse polarity) until the sounder is required to operate. When the signaling device is required to operate the polarity is changed to normal supply and the sounder will go into **Active mode** where it will start to sound the correct tone. When testing the system and sounders operation the system is put into **Active mode**.

The customer PLC will control whether the system is in either of the main two operational modes.

**Standby Mode** – This is where the power supply polarity is reversed so negative (–ve) is feed to the positive (+) sounder terminal and positive (+) is feed to the negative (–ve) sounder terminal.

In this mode the sounder will not sound the tone but the SIL 2 unit is monitoring power supply and is set-up ready to go to Active (alarm) mode.

Power relay RLY1-1 will be open whilst SIL 2 relay RLY1-2 will be closed contact between terminals 1 & 2.

If power is disrupted the SIL 2 unit will go into **Fault mode**, in fault mode the Power relay RLY1-1 will close whilst SIL 2 relay RLY1-2 will become open circuit between terminals 1 & 2.

**Active Mode** – This is where the power is in normal polarity, positive (+) supplied to the positive (+) sounder terminal and negative (-ve) is supplied to the negative (-ve) sounder terminal.

In this mode the sounder will sound tone giving the warning signal, the SIL 2 unit is actively checking the sounders function for tone output and sounder controller signal generation to the right tone frequency.

Power relay RLY1-1 will be open whilst SIL 2 relay RLY1-2 will be closed contact between terminals 1 & 2.

The SIL 2 unit will also check for signal polarity.

If a fault is found the SIL 2 unit will go into **Fault mode**.

If power is disrupted the SIL 2 unit will go into **Fault mode**, in fault mode the Power relay RLY1-1 will close whilst SIL 2 relay RLY1-2 will become open be circuit between terminals 1 & 2.

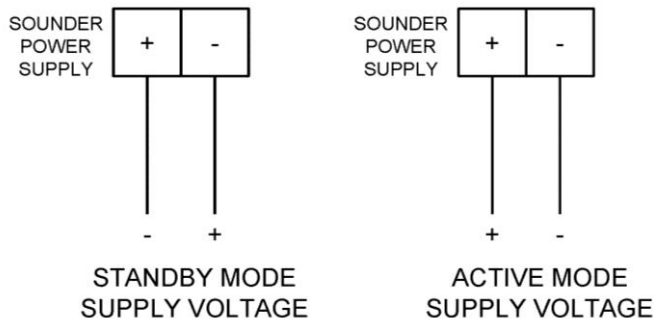

**Fault modes** - The fault modes listed 17-1 & 17-2 below will make the SIL 2 unit change the state of the fault relays  
In fault mode the Power relay RLY1-1 will close whilst SIL 2 relay RLY1-2 will become open circuit between terminals 1 & 2.

### 15-1 Sounder Failure

- Tone Failure – No Tone detected
- Sounder Controller failure – No tone generation pulse detected
- Tone Rate Failure – Regular tone cycle erratic

Resetting Failure - It is possible that the SIL 2 unit can be reset by powering the unit off for a period greater than 20 seconds. On restarting the unit and running through the commissioning cycle the fault may clear. It is necessary to run the test function cycle again to see if the fault is still evident. If the relays activate again the unit must be checked as it is showing a failure and may not be functioning correctly.

### 15-2 Power Failure / SIL 2 Failure

- SIL 2 Controller failure – Internal function and system checking flags fault
- Rapid Power cycling – System indicates power instability
- Total Power Failure

Resetting Failure - It is possible that the SIL 2 unit can be reset by hard resetting the unit using the reset jumper within the unit (see section 24) on hard resetting.

On restarting the unit and running through the commissioning cycle, the fault may clear. It is necessary to run the test function cycle again to see if the fault is still evident. If the relays activate again the unit must be checked as it is currently showing a failure and may not be functioning correctly.

### **Commissioning System - Functional start-up of System (Normally in reverse polarity mode)**

When Commissioning system the power must not be disrupted to the SIL 2 Unit within the unit's initialization cycle which is **5 seconds**.

Once past this period the SIL 2 system is fully operational and will be in monitoring the sounder and power in Standby mode.

The relay RLY1-2 on the SIL 2 unit will only remain open for a maximum of 1 second on commissioning start-up. Then they will close contact 1 & 2 showing healthy operation and only open in the event of a fault or power down.

### **System Testing (Active Mode normal polarity)**

The SIL 2 system will remain monitoring the power in standby mode until the polarity is changed to normal mode to enable an active system for sounder functional testing.

**Important:** - The polarity must be held in active mode for a period in excess of **15 seconds** to ensure a full system check is performed.

Whilst the system is being checked the sounder controller and tone pattern are monitored and checked for correct pattern timing.

Once the test period has been completed the unit can be switched back to standby mode by reversing the polarity.

If no faults have been found during the test the relays will remain in steady state.

The SIL 2 unit will continue to monitor the power and mode.

**Important:** - The automated test cycle **must** be undertaken on at least a weekly basis to maintain the SIL 2 units reliability.

### **System Activation (Active Mode normal polarity)**

The SIL 2 system will remain monitoring the power in standby mode until the polarity is changed to Active mode to enable an active system for sounder to function as a warning signaling device.

**Important:** :- The polarity must be held in active mode for a period in excess of 15 seconds to ensure a full system check is performed whilst in alarm mode, although it is expected that during a system activation this period will be significantly greater.

**Note** :- The fault indication signal on TB1 can take up to 50 milliseconds to indicate system fault.



## 16) SIL 2 Wiring configuration and Sounder set-up

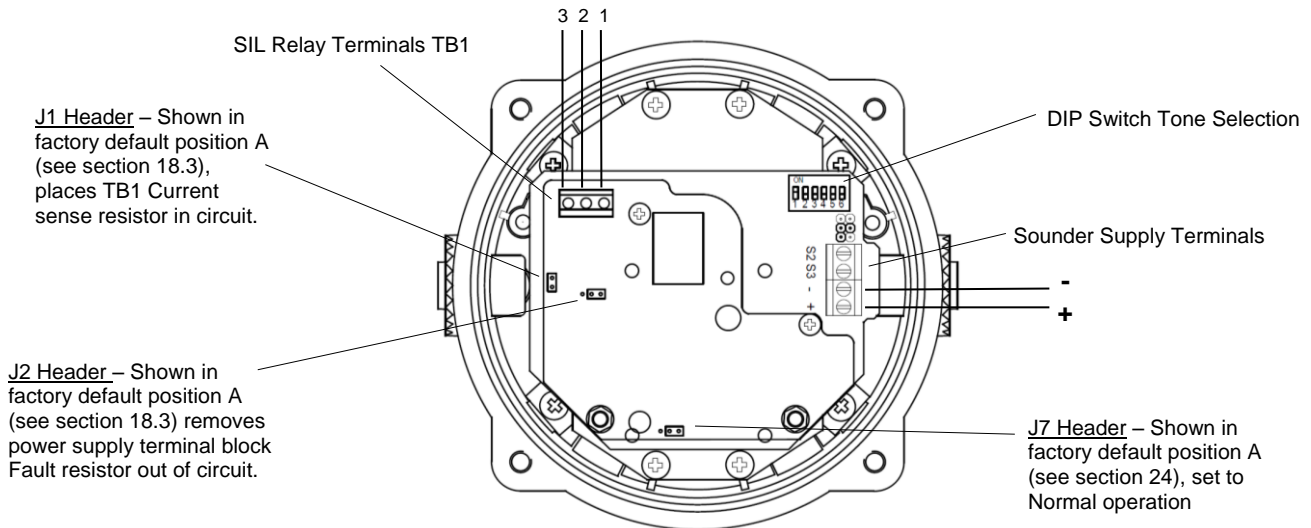

Figure 8 – Terminals and header pins for sounder

Power & Communication with the system control panel can be configured in two ways: - Although it is **highly** recommended that the unit is wired as stated in this section 18-1

- **16-1 SIL 2 system wiring for fault detection in standby and active mode – 4 wire installation (Recommended)**

The customer is required to wire into both the sounder power supply terminals block and also the SIL 2 Relay terminals TB1

The power supply terminals only need to have the supply power connected. This will be reverse polarity for monitoring mode and normal polarity for active mode. There is no need to fit an EOL resistor on the power supply terminal block as the TB1 is configured to raise a fault alarm in any situation.

TB1 the SIL 2 monitoring relay, RLY 1-2 on the SIL 2 board which whilst powered is closed between TB1 terminals 1 & 2, however on any fault will become an open circuit between TB1 terminals 1 & 2. The fault will be seen via the SIL 2 TB1 terminals as soon as the fault occurs in either Active or Standby modes.

As factory default when there is no fault, the TB1 terminals 1 & 2 will be closed putting a 3.3kΩ current sense resistor in line. If the circuit is driven with 24V dc the detection current seen is ~7.3mA @ 24V.

System faults will make RLY 1-2 contacts go open circuit between terminals 1 & 2 for any fault mode. The only other fault mode is if the cable goes short circuit where a short will be seen by the panel.

There is an option (although not recommended) to alter the enable J1 header pin to link pins 1 & 2 (see figure 11) which shorts out the 3.3KΩ current sense resistor making TB1 terminal 1 & 2 into a switch. The disadvantage is that a short circuit on this cable will not be detected.

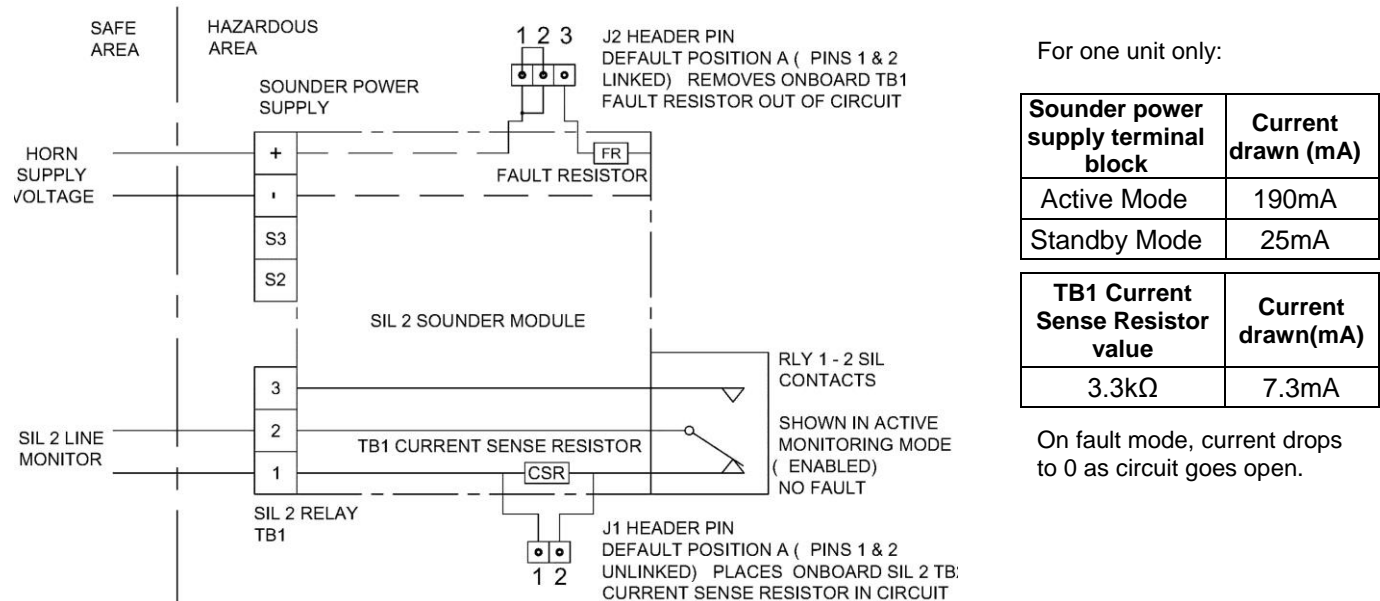

For one unit only:

Sounder power supply terminal block	Current drawn (mA)
Active Mode	190mA
Standby Mode	25mA

TB1 Current Sense Resistor value	Current drawn (mA)
3.3kΩ	7.3mA

On fault mode, current drops to 0 as circuit goes open.

Figure 9 - Schematic of SIL 2 system wiring for fault detection in standby and active mode – 4 wire installation

## Multiple Unit Configuration

When multiple units are used in the system, the following considerations are to be made by the customer:

1. Customer panel capabilities -  
The customer is required to identify the minimum change in current the panel can detect (Panel resolution). This will therefore determine what resistors values to pick in section 3 below.
2. Topology -  
The customer has a number of options on how to set up the system.
  - A single unit topology is where only one unit is connected to the customer interface line, as shown in figure 9.
  - A series topology is where each unit is connected to one another as shown in figure 14.
  - A star topology is where each unit is connected to a central source as shown in figure 15.
3. Resistor - TB1 Current Sense Resistor (default 3.3kΩ)  
The customer is required to calculate the total resistance of the system, to determine the change in current when a fault occurs. The default customer sense resistor value is 3.3kΩ. Examples of calculations of resistance for steady mode and fault mode are shown in table 1.

Panel Resolution	Topology	Resistor: TB1 CSR	No. of Units	Steady Mode: Active/Monitoring	Fault Mode	
					1 unit fault	All units fault
2mA	Series	3.3kΩ	3	$3 \times 3.3k\Omega = 9.9k\Omega$ $\frac{24}{9.9k\Omega} = 2.4mA$	0mA If one unit fails the whole system fails	
7mA	Star	3.3kΩ	3	$(3.3k\Omega \sim 7.3mA)$ $3 \times 7.3mA = 21.9mA$	(Fault unit): $1 \times 0mA = 0mA$ (Normal): $2 \times 7.3mA = 14.6mA$	(Fault unit): $3 \times 0mA = 0mA$
1.5mA	Series	3.3kΩ	4	$4 \times 3.3k\Omega = 13.2k\Omega$ $\frac{24}{13.2k\Omega} = 1.8mA$	0mA If one unit fails the whole system fails	
7mA	Star	3.3kΩ	4	$(3.3k\Omega \sim 7.3mA)$ $4 \times 7.3mA = 29.2mA$	(Fault unit): $1 \times 0mA = 0mA$ (Normal): $3 \times 7.3mA = 21.9mA$	(Fault unit): $4 \times 0mA = 0mA$

Table 1

Note: - Cable fault

- Between the panel and the first unit, a cable short, increases the current (presenting a short circuit to the panel), and a cable cut/open reduces current (presenting an open circuit to the panel).
- In series topology a cable short between units will short out one of the current sense resistors which results in an increase in the current used by the unit, and a cable cut/open reduces current (presenting an open circuit to the panel).
- In star topology a cable short between units will short circuit the SIL 2 monitoring line hence presenting a short circuit to the panel, an open circuit fault on one of the units will effectively remove one of the current sense resistors reducing total effective resistance hence decreasing the total current seen by the panel.

• **16-2 SIL 2 system wiring for fault detection in standby mode only – 2 wire installation**

The customer is required to wire into power supply terminal only. The unit will be monitored in standby mode only, via an customer installed system EOL resistor (2.2kΩ suggested customer EOL and default 2.2kΩ fault resistor will draw a total current of 35.9mA @ 24Vdc as shown in table 2).

In the event of a fault, The SIL 2 unit will automatically place the power supply terminal fault resistor across the power terminals which already has customer EOL resistor (2.2kΩ) in place. This will result in a total fault detection current of 41.8mA @ 24V but can only be detected when unit is in Standby Mode.

If the customer chooses to use this configuration within their system, it must be noted that the factory default settings for the unit does not have an EOL resistor installed. The customer can request E2S to install an EOL resistor and this will be depicted in the product code. See section 25 for further information on EOL and fault resistor value choice.

**Important:** - This configuration will not warn of a fault whilst in Active mode as the PLC will be supplying the unit with power. The PLC will only be able to see the fault when in standby mode, by measuring the fault detection current.

**Important:** - This configuration requires the customer to set J2 header pin to be set to position B (see figure 12), as the units default position is A.

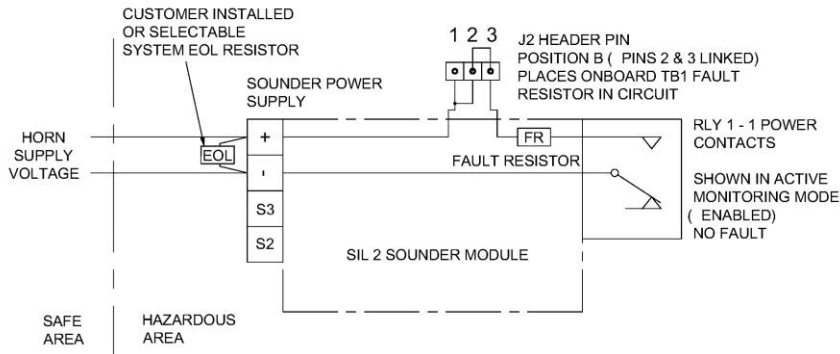

Figure 10 - Schematic of SIL 2 system wiring for fault detection in standby mode only – 2 wire installation

To evaluate the total current drawn from the SIL 2 unit, use the equation below.

$$I_{\text{(Total Current drawn)}} = I_{\text{FR (Current drawn from Fault Resistor)}} + I_{\text{EOL (Current drawn from Customer EOL resistor)}} + I_{\text{SIL (Current drawn from SIL board)}}$$

In standby mode, where there is no fault, RLY 1-1 is open. This means the voltage only passes through the customer EOL resistor and the current drawn from the SIL 2 board is 25mA. Therefore, the equation for a No Fault scenario is then:

$$I_{\text{NF (Standby Mode, Total Current drawn - No Fault)}} = I_{\text{FR (0mA)}} + I_{\text{EOL (See table 2)}} + I_{\text{SIL (25mA)}}$$

In standby mode, where there is a fault, the circuit is closed. This means the voltage passes through both the customer EOL resistor and current sense resistor and the current drawn from the SIL 2 board is 20mA. The customer must first calculate the resistance of the two resistors in parallel before applying the currents to the equation. The equation for a Fault scenario is then:

$$I_{\text{F (Standby Mode, Total Current drawn - Fault)}} = I_{\text{TR (Total Resistance when EOL & FR in parallel)}} + I_{\text{SIL (20mA)}}$$

Standby Mode	Power Supply Fault Resistor		Customer EOL Resistor		(Fault Mode Only)		Current drawn from SIL Board	Total current drawn
	Resistor Value	Current drawn ( $I_{\text{FR}}$ )	Resistor Value	Current drawn ( $I_{\text{EOL}}$ )	Total resistance	Current drawn ( $I_{\text{TR}}$ )		
No Fault	2.2 kΩ	0 mA	2.2 kΩ	10.9 mA	-	-	25 mA	35.9 mA
Fault		-		-	1.1 kΩ	21.8 mA	20 mA	41.8 mA
No Fault	1.0 kΩ	0 mA	1.0 kΩ	24.0 mA	-	-	25 mA	49.0 mA
Fault		-		-	500 Ω	48.0 mA	20 mA	68.0 mA
No Fault	2.2 kΩ	0 mA	3.3 kΩ	7.3 mA	-	-	25 mA	32.3 mA
Fault		-		-	1.3 kΩ	18.2 mA	20 mA	38.2 mA
No Fault	1.8 kΩ	0 mA	3.9 kΩ	6.2 mA	-	-	25 mA	31.2 mA
Fault		-		-	1.2 kΩ	19.5 mA	20 mA	39.5 mA
No Fault	1.8 kΩ	0 mA	4.7 kΩ	5.1 mA	-	-	25 mA	30.1 mA
Fault		-		-	1.3 kΩ	18.4 mA	20 mA	38.4 mA
No Fault	2.2 kΩ	0 mA	4.7 kΩ	5.1 mA	-	-	25 mA	30.1 mA
Fault		-		-	1.5 kΩ	16.0 mA	20 mA	36.0 mA

Table 2: Resistor combinations and the currents drawn when no faults and faults occur

## Multiple Unit Configuration

When multiple units are used in the system, the following considerations are to be made by the customer:

1. Customer panel capabilities -  
The customer is required to identify the minimum change in current the panel can detect (Panel resolution). This will therefore determine what resistors values to pick in section 3 below.
2. Topology -  
The customer has a number of options on how to set up the system.
  - A single unit topology is where only one unit is connected to the customer interface line, as shown in figure 10.
  - A series topology is when each unit is connected to one another as shown in figure 16.
  - A star topology is when each unit is connected to a central source as shown in figure 17.
3. Resistor -  
The customer is required to calculate the total resistance a system, to determine the change in current when a fault occurs. As mentioned above, the customer can select a system EOL resistor. The default fault resistor value is 2.2kΩ which is recommended and is fitted according to the configuration topology chosen.

Panel Resolution	Topology	Resistor: Power Supply FR & EOL	No. of Units	Steady Mode Active/Monitoring	Fault Mode		
					1 unit fault	2 units fault	All units fault
5.5mA	Series	FR = 2.2kΩ & EOL = 2.2kΩ	3	EOL Only	EOL + FR	EOL + (2 x FR)	EOL + (3 x FR)
				$\frac{24}{2.2k\Omega} = 10.9mA$ $3 \times 25mA = 75mA$ $I = 85.9mA$	$R_T = 1.1k\Omega$ $\frac{24}{1.1k\Omega} = 21.8mA$ $2 \times 25mA = 50mA$ $1 \times 20mA = 20mA$ $I = 91.8mA$	$R_T = 0.7k\Omega$ $\frac{24}{0.7k\Omega} = 32.7mA$ $1 \times 25mA = 25mA$ $2 \times 20mA = 40mA$ $I = 97.7mA$	$R_T = 0.55k\Omega$ $\frac{24}{0.55k\Omega} = 43.6mA$ $3 \times 20mA = 60mA$ $I = 103.6mA$
5.5mA	Star	FR = 2.2kΩ & EOL = 2.2kΩ	3	3 x EOL	(3 x EOL) + (1 x FR)	(3 x EOL) + (2 x FR)	(3 x EOL) + (3 x FR)
				$R_T = 0.7k\Omega$ $\frac{24}{0.7k\Omega} = 32.7mA$ $3 \times 25mA = 75mA$ $I = 107.7mA$	$R_T = 0.55k\Omega$ $\frac{24}{0.55k\Omega} = 43.6mA$ $2 \times 25mA = 50mA$ $1 \times 20mA = 20mA$ $I = 113.6mA$	$R_T = 0.44k\Omega$ $\frac{24}{0.44k\Omega} = 54.5mA$ $1 \times 25mA = 25mA$ $2 \times 20mA = 40mA$ $I = 119.5mA$	$R_T = 0.36k\Omega$ $\frac{24}{0.36k\Omega} = 66.6mA$ $3 \times 20mA = 60mA$ $I = 126.6mA$
5.5mA	Series	FR = 2.2kΩ & EOL = 3.3kΩ	3	EOL Only	EOL + FR	EOL + (2 x FR)	EOL + (3 x FR)
				$\frac{24}{3.3k\Omega} = 7.3mA$ $3 \times 25mA = 75mA$ $I = 82.3mA$	$R_T = 1.3k\Omega$ $\frac{24}{1.3k\Omega} = 18.2mA$ $2 \times 25mA = 50mA$ $1 \times 20mA = 20mA$ $I = 88.2mA$	$R_T = 0.8k\Omega$ $\frac{24}{0.8k\Omega} = 30mA$ $1 \times 25mA = 25mA$ $2 \times 20mA = 40mA$ $I = 95mA$	$R_T = 0.6k\Omega$ $\frac{24}{0.6k\Omega} = 40mA$ $3 \times 20mA = 60mA$ $I = 100mA$
5.5mA	Star	FR = 2.2kΩ & EOL = 3.3kΩ	3	3 x EOL	(3 x EOL) + (1 x FR)	(3 x EOL) + (2 x FR)	(3 x EOL) + (3 x FR)
				$\frac{24}{1.1k\Omega} = 21.8mA$ $3 \times 25mA = 75mA$ $I = 96.8mA$	$R_T = 0.7k\Omega$ $\frac{24}{0.7k\Omega} = 32.7mA$ $2 \times 25mA = 50mA$ $1 \times 20mA = 20mA$ $I = 102.7mA$	$R_T = 0.55k\Omega$ $\frac{24}{0.55k\Omega} = 43.6mA$ $1 \times 25mA = 25mA$ $2 \times 20mA = 40mA$ $I = 108.6mA$	$R_T = 0.44k\Omega$ $\frac{24}{0.44k\Omega} = 54.5mA$ $3 \times 20mA = 60mA$ $I = 114.5mA$

Table 3

Note: - Cable fault

- Between the panel and the first unit, a cable short, increases the current (presenting a short circuit to the panel), and a cable cut/open reduces current (presenting an open circuit to the panel).
- In series topology a cable short between units will short out one of the current sense resistors which results in an increase in the current used by the unit, and a cable cut/open reduces current (presenting an open circuit to the panel).
- In star topology a cable short between units will short circuit the SIL 2 monitoring line hence presenting a short circuit to the panel, an open circuit fault on one of the units will effectively remove one of the current sense resistors reducing total effective resistance hence decreasing the total current seen by the panel.

### 16-3 Header Pins Settings

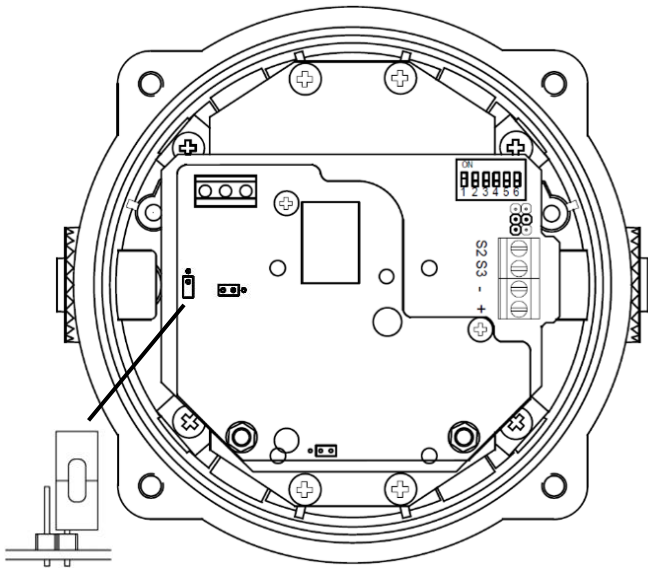

J1 Header Pin - Position A, Factory default position (pins 1 & 2 not linked) places TB1 Current sense resistor in circuit.

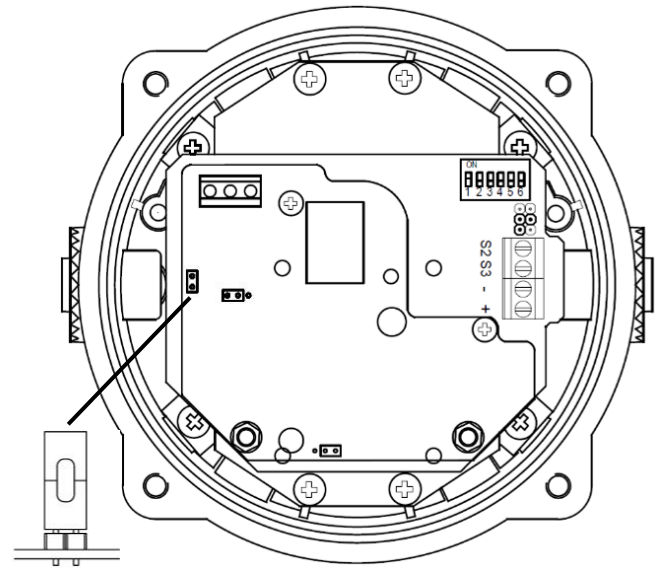

J1 Header Pin - Position B (pins 1 & 2 linked) removes TB1 Current sense resistor out of circuit.

Figure 11: J1 Header pin positions

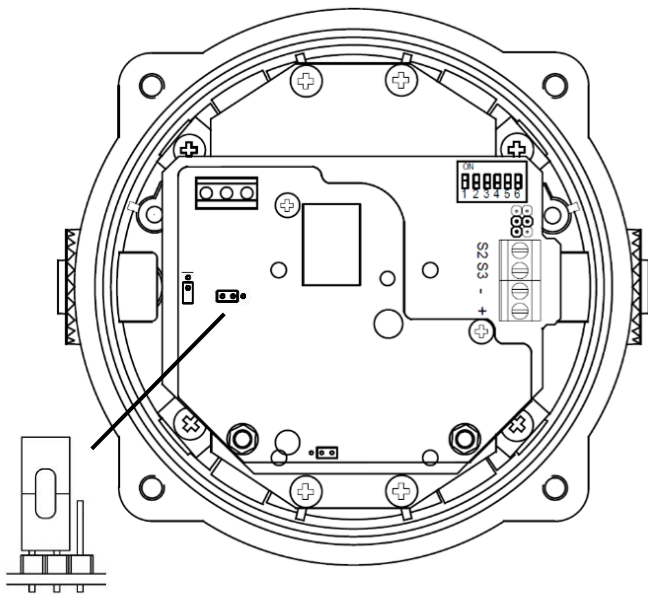

J2 Header Pin - Position A, Factory default position (pins 1 & 2 linked) removes power supply terminal Fault resistor & RLY 1-2 out of circuit.

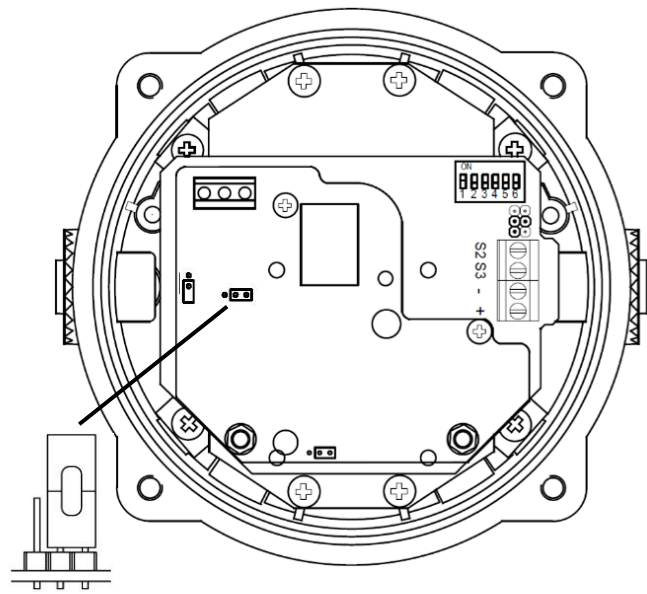

J2 Header Pin - Position B (pins 2 & 3 linked) places power supply terminal Fault resistor & RLY 1-2 in circuit.

Figure 12: J2 Header pin positions

## 17) SIL 2 Specific Unit Mounting Requirements

The sounder should be mounted no closer than 5m from a sounder source of similar SPL output. This is to ensure false tone activation does not occur when the unit is monitoring the tone pulse duration and tone failure.

## 18) SIL 2 Reliability Data

Reliability and Functional safety IEC/EN61508 which has been assessed and is considered suitable for use in low demand safety function:

- Random Hardware Failures and Architectural constraints (route 1+)
- As an unvoted item (ie hardware fault tolerance of 0) at SIL 2

The product was assessed against failure modes:

- Failure respond to an input with a correct tone
- Failure to respond to an input even with an alternative tone
- Spurious sound output despite no input

### BExS110D-SIL (Correct tone needed)

Integrity in respect of failure to release	SIL 2
Total Failure rate	0.304 pmh
"hazardous" failure rate (revealed)	0.233 pmh
"hazardous" failure rate (unrevealed)	0.017 pmh
"safe" failure rate (revealed)	0
"safe" failure rate (unrevealed)	0
Diagnostic Coverage	93%
System type	B
Hardware Fault Tolerance	0
Safe Failure Fraction	>93%
PFD (hazardous failure)	$9.4 \times 10^{-5}$
Proof Test Interval	Up to 1 week

### BExS110D-SIL (Total failure)

Integrity in respect of failure to release	SIL 2
Total Failure rate	0.304 pmh
"hazardous" failure rate (revealed)	0.235 pmh
"hazardous" failure rate (unrevealed)	0.005 pmh
"safe" failure rate (revealed)	0.01
"safe" failure rate (unrevealed)	0
Diagnostic Coverage	98%
System type	B
Hardware Fault Tolerance	0
Safe Failure Fraction	>98%
PFD (hazardous failure)	$2.0 \times 10^{-5}$
Proof Test Interval	Up to 1 week

## 19) Synchronised Operation

All BExS110D-SIL sounders that are connected to the same supply line will be synchronised as tone as the same tone pattern is selected.

## 20) End of Line Monitoring

On BExS110D-SIL DC units, DC reverse line monitoring can be used if required. All DC sounders have a blocking diode fitted in their supply input lines. An end of line monitoring diode or an end of line monitoring resistor can be connected across the +ve and -ve terminals.

We suggest that with the SIL 2 system, the customer selected EOL resistor is kept to a value of 2.2kΩ however variation is allowed as required by the SIL 2 systems PLC parameters. See section 18.2 & 25.

Values of current draw are given for the 2.2kΩ resistor if used as set up in section 18.

If an alternative value end of line resistor is used it must have a minimum resistance value of 3.3kΩ and a minimum wattage of 0.5 watts or a minimum resistance value of 500Ω and a minimum wattage of 2 watts.

## 21) SIL 2 Hard Reset

If required to hard system reset the unit, firstly, the unit will need to be opened, to carry out this operation see section 7.

**Warning:** - Ensure that an explosive atmosphere is not present during reset operation.

Power down the unit completely for a minimum of 30 seconds. Move the hard reset header pin (Jumper J7) to reset position B shown. Then power the unit for a minimum of 5 seconds. Power down the unit for 30 seconds and then move the header pin back to Position A.

The unit has been reset. Close the unit as noted in section 8. If the hard reset does not correct the fault the unit or power supply integrity will need further investigation.

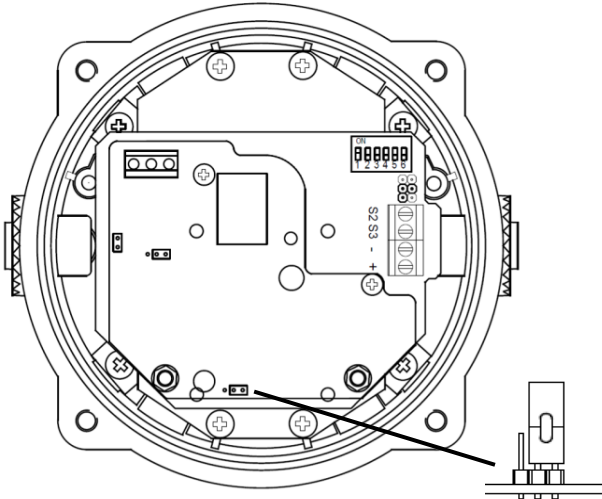

J7 Header Pin - Position A, Factory default position (pins 2 & 3 linked) set to normal operation.

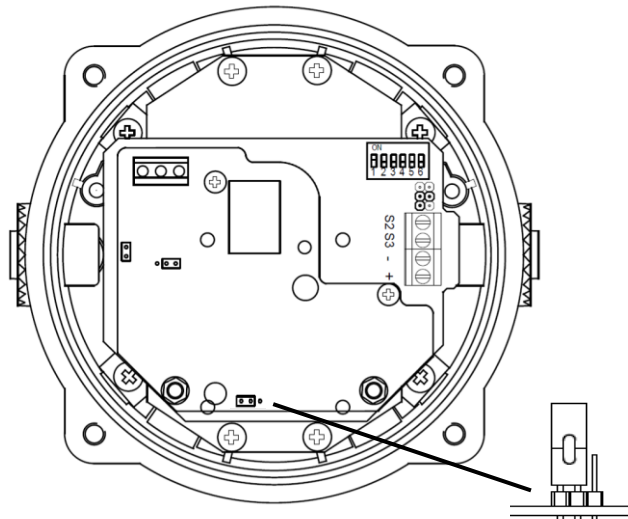

J7 Header Pin - Position B (pins 2 & 3 linked) set for hard reset.

Fig 13 - Hard reset Jumper settings

## 22) Product Coding for Fault Resistor and Customer EOL Resistor

The customer is able to identify the resistor values chosen on purchase from the product code. This is represented by the last two characters:

BEXS110D-SIL-**XX**

The first character denotes the value of the Fault resistor and the second character denotes the value of the EOL resistor. The values of resistors available are shown in table 4.

Code	Resistor Value
A	2.2 kΩ
B	1.0 kΩ
C	1.5 kΩ
D	1.8 kΩ
E	2.7 kΩ
F	3.3 kΩ
G	3.9 kΩ
H	4.7 kΩ
J	5.6 kΩ
K	6.8 kΩ
L	8.2 kΩ
M	11 kΩ
Z	None Fitted

Table 4: Resistor values

For Example:

BEXS110D24DC-SIL-AZ

This shows a standard 24V dc S110 SIL 2 sounder with the suggested 2.2kΩ fault resistor and no customer installed or selectable EOL resistor.

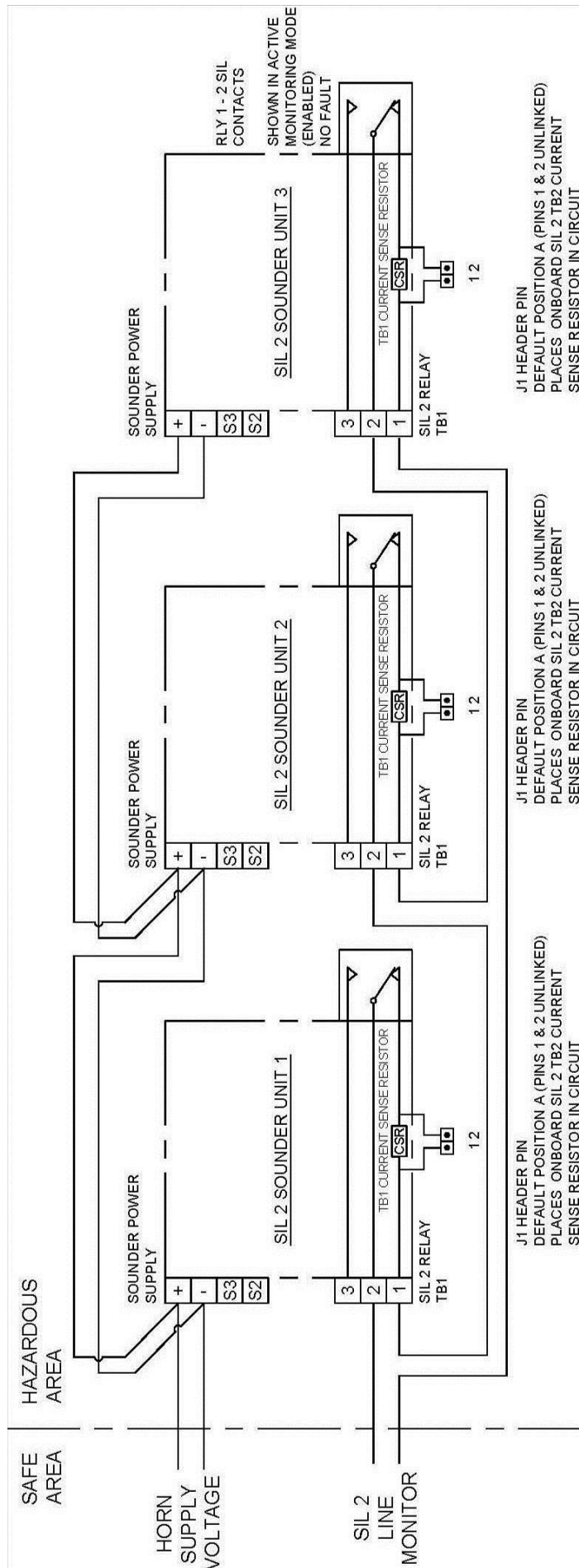

Figure 14 – Schematic of 18-1 SIL 2 system wiring for fault detection in standby and active mode – 4 wire installation wired in series.



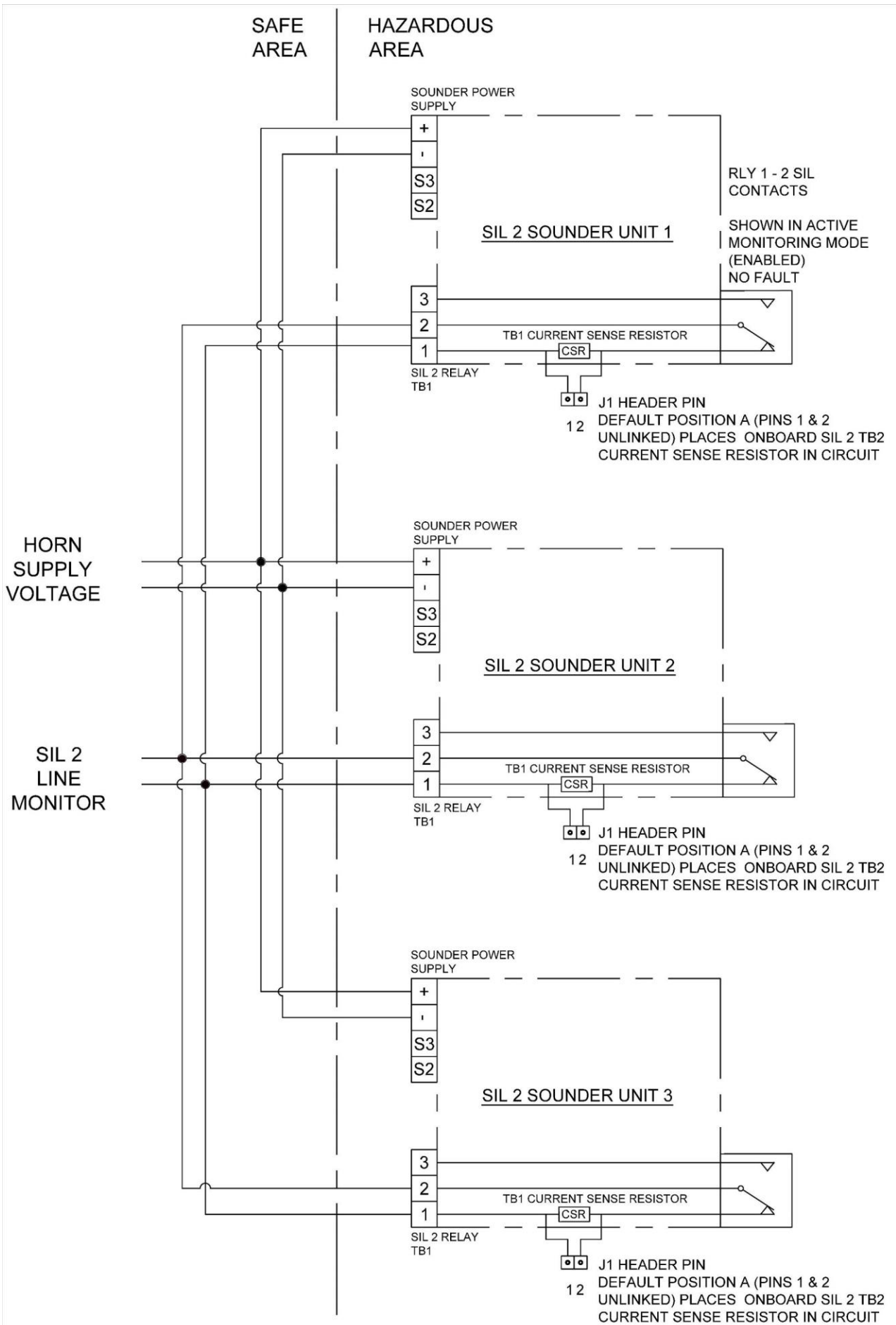

Figure 15 - Schematic of 18-1 SIL 2 system wiring for fault detection in standby and active mode – 4 wire installation in star formation.

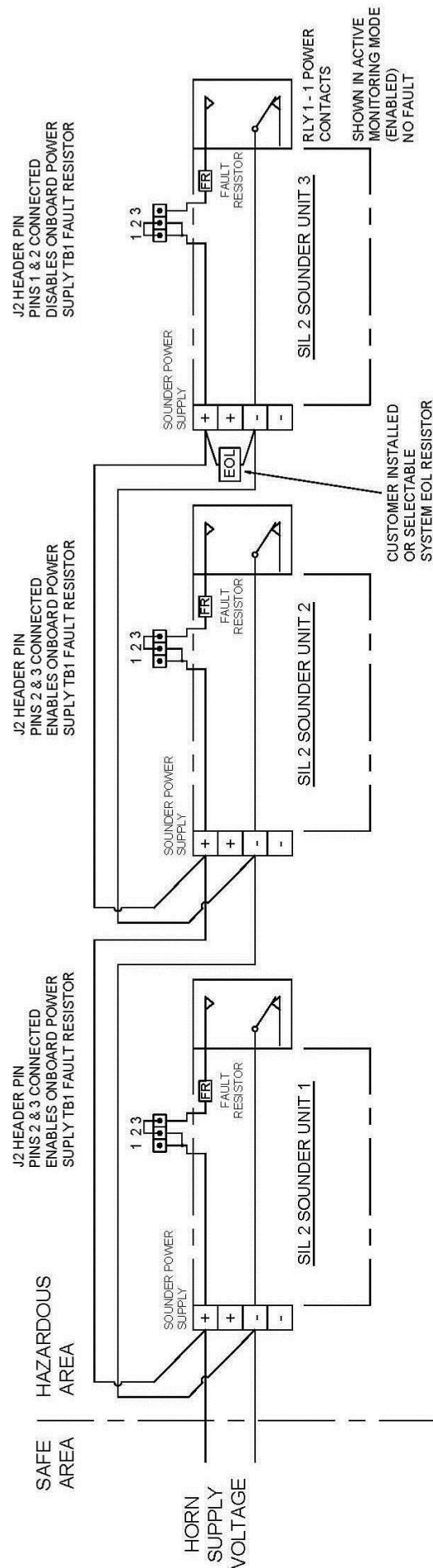

Figure 16 – Schematic of 18-2 SIL 2 system wiring for fault detection in standby mode only – 2 wire installation wired in series.

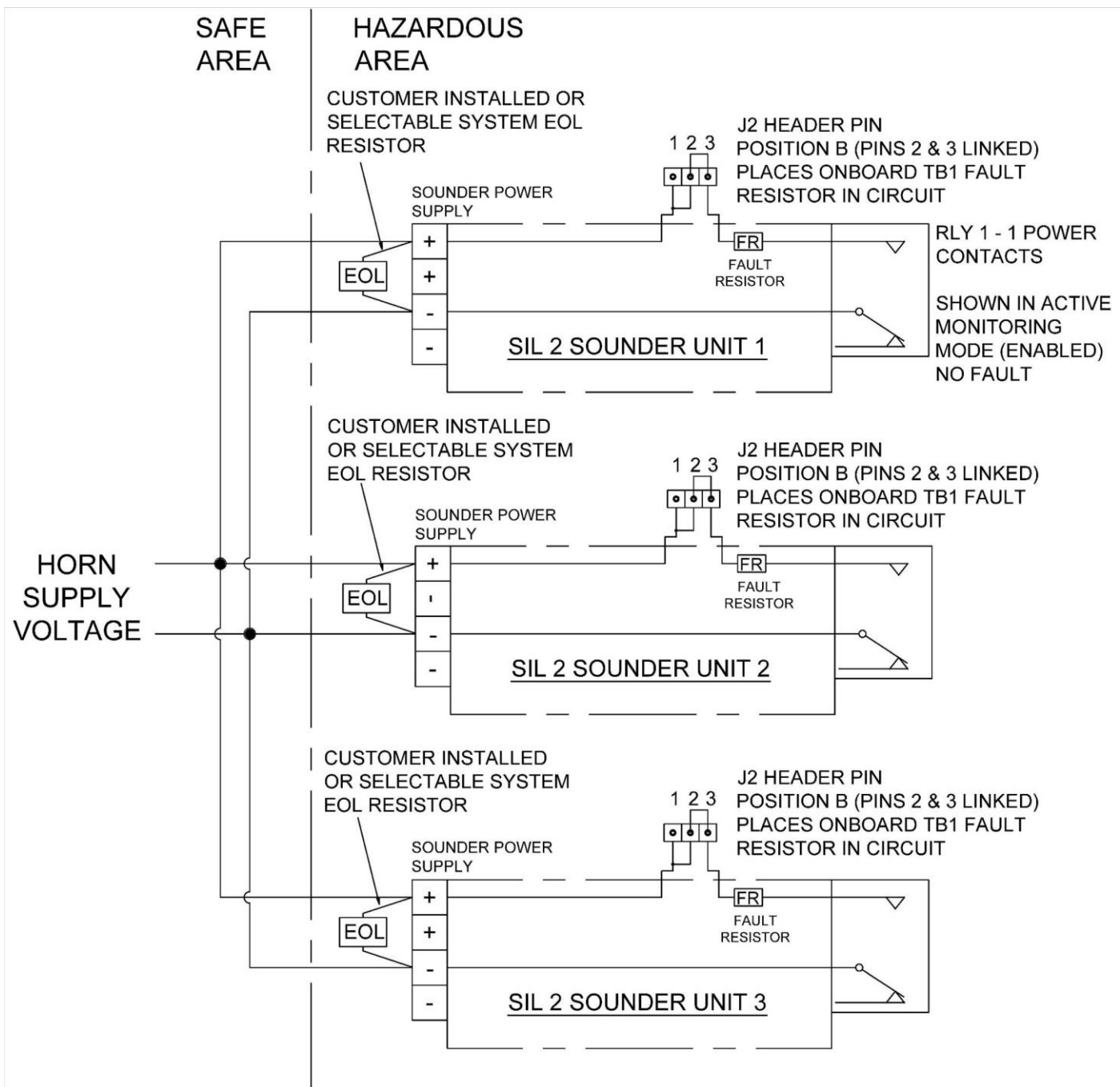

Figure 17 - Schematic of 18-2 SIL 2 system wiring for fault detection in standby mode only – 2 wire installation in star formation.

# EU Declaration of Conformity



**Manufacturer:** European Safety Systems Ltd.  
Impress House, Mansell Road, Acton  
London, W3 7QH, United Kingdom

**Equipment Type:** BExS110D-SIL, BExDS110D-SIL

---

## Directive 2014/34/EU: Equipment and Protective Systems for use in Potentially Explosive Atmospheres (ATEX)

Notified Body for EU type Examination (Module B):	Dekra Certification B.V. Notified Body No.: 0344 Meander 1051, 6825 MJ Arnhem, The Netherlands
EU-type Examination Certificate (Module B):	KEMA 99ATEX6312X
Notified Body for Quality Assurance Notification / Conformity to EU-type based on quality assurance of the production process (Module D):	Sira Certification Service Notified Body No.: 0518 Rake Lane, Eccleston, Chester CH4 9JN, UK
Quality Assurance Notification (Module D):	SIRA 05 ATEX M342
Provisions fulfilled by the equipment:	II 2G Ex d IIB or IIC T4 Gb II 2D Ex tb IIIC T100°C or T115°C Db IP6X Dust Protection to EN60079-0 / EN60079-31
Standards applied:	EN 60079-0:2012 + A11:2013 EN 60079-1:2007 EN 60079-31:2014

## Directive 2014/30/EU: Electromagnetic Compatibility Directive (EMC)

Standards applied:	EN 61000-6-1:2007 EN 61000-6-2:2005 EN 61000-6-3:2007 / A1:2011 / AC: 2012 EN 61000-6-4:2007 / A1: 2011
--------------------	--

## Directive 2011/65/EU: Restriction of the use of certain hazardous substances in electrical and electronic equipment (RoHS)

The product and all the components contained within it are in accordance with the restriction of the use of hazardous substances in electrical and electronic equipment.

## Regulation (EC) 1907/2006: Registration, Evaluation, Authorisation and Restriction of Chemicals (REACH)

The product and all the components contained within it are free from substances of very high concern.

## Other Standards and Regulations

Safety Integrity Level: suitable for SIL2 (for product software and hardware)  
System Capability: suitable for SC=2 (for product software and hardware)  
System Capability assessment: 1s (by cross-functional team assessment)  
IEC 61508-1 (2010) Functional safety of electrical/electronic/programmable electronic safety-related systems - Part 1: General requirements  
IEC 61508-2 (2010) Functional safety of electrical/electronic/programmable electronic safety-related systems - Part 2: Requirements for electrical/electronic/programmable electronic safety-related systems  
IEC 61508-3 (2010) Functional safety of electrical/electronic/programmable electronic safety-related systems - Part 3: Software requirements

EN 60529:1991 + A1:2000 + A2:2013 - Degrees of protection provided by enclosures (IP code) – **enclosure rated IP66/67**

---

On behalf of European Safety Systems Ltd., I declare that, on the date the equipment accompanied by this declaration is placed on the market, the equipment conforms with all technical and regulatory requirements of the above listed directives, regulations and standards.

This Declaration is issued under the sole responsibility of the manufacturer.

  
**Martin Streetz**  
Quality Assurance Manager

**Document No.:** DC-064\_Issue\_E  
**Date and Place of Issue:** London, 19/04/2016