

Emergency pull-wire switch

// ZS 441 20 VS / 220 N Order no.: 74541601

Features/Options

- Metal enclosure
- 2 contacts
- Wire length up to 25 m

- Spring force variant (actuating force): 220 N for 15-25 m
- Release by key
- Wire pull and breakage function

Dimensions

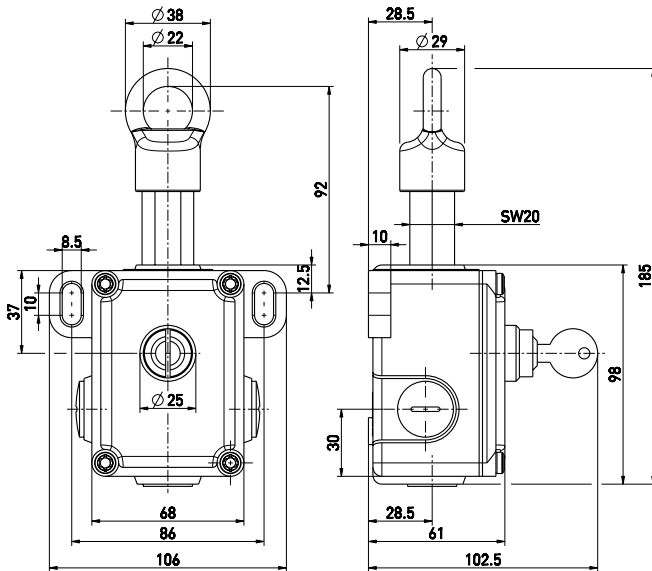

Technical data

Standards	EN ISO 13849-1; IEC/EN 60947-5-1; IEC/EN 60947-5-5; EN 418
Enclosure	aluminium die-cast, powder-coated
Cover	aluminium die-cast, powder-coated
Degree of protection	IP 54 to IEC/EN 60529
Contact material	silver
Switching elements	2 NC with double break
Switching system	snap action, positive break NC contacts ⊖
Connection	screw terminals
Cable section	max. 2.5 mm ² (incl. conductor ferrules)
Cable entry	3 x M20 x 1.5
B_{10d} (10% Load)	200.000
T_M	max. 20 years
U_{imp}	6 kV
U_i	400 V
I_{the}	6 A
Utilisation category	AC-15
I_e/U_e	6 A/400 VAC
Max. fuse rating	6 A gL/gG D-fuse
Ambient temperature	-25 °C ... +70 °C
Mech. life	> 100.000 operations
Max. wire length	25 m
Features	wire pull and breakage function
Approvals	
Weight	662g

Switching diagram

Snap action
2 NC contacts

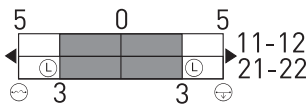

Contact diagram

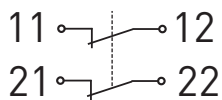

Errors and omissions excepted.