

Accessories for Magnetic sensors, cylindrical form // M 100 NU Order no.: 01.24.0005

Features/Options

- Unenclosed
- Barium ferrite
- Ambient temperature:
-20 °C ... +80 °C

Dimensions

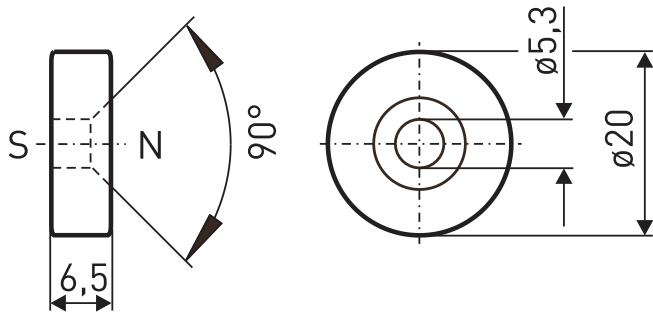

Errors and omissions excepted.