

# PA 5 / PA X 5-05/ PA X 5-10 - Betriebs- und Montageanleitung

## Maße

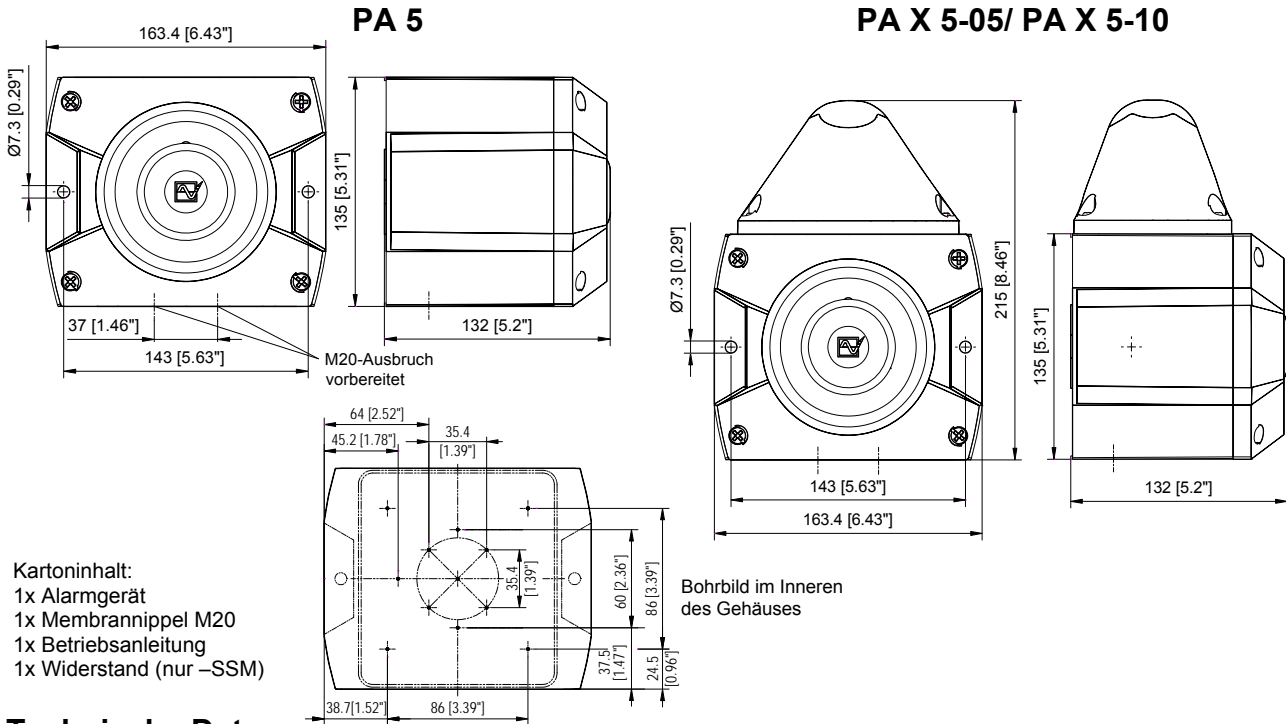

## Technische Daten

	PA 5				PA X 5-05/ PA X 5-10					
Nennschallpegel	105dB (A) 1m									
Lautstärkeregelung	max. -12dB									
Töne	80									
Blitzenergie	-				PA X 5-05: 5J / PA X 5-10: 10J					
Blitzfolgefrequenz	-				1Hz					
Bemessungsspannung (Begrenzungen siehe Zulassungen)	24V DC oder 12 – 48 V DC	24V AC 50/60 Hz	115V AC 50/60 Hz	230V AC 50/60 Hz	12V DC	24V DC	48V DC	24V AC 50/60 Hz	115V AC 50/60 Hz	230V AC 50/60 Hz
Spannungsbereich	10 - 57 V DC	18-30 V AC	95 – 127 V AC	195 – 253 V AC	10-15 V DC	18-30 V DC	40-57 V DC	18-30 V AC	95 – 127 V AC	195 – 253 V AC
Stromaufnahme Schallgeber (max)	80 mA	150 mA	30 mA	16 mA	25 mA	70 mA	80 mA	150 mA	30 mA	16 mA
Stromaufnahme Blitzleuchte (max)	-	-	-	-	5 J: 700 mA 10 J: 1400 mA	5J: 360 mA 10 J: 680 mA	5 J: 170 mA 10 J: 300 mA	5 J: 800 mA 10 J: 1400 mA	5 J: 120 mA 10 J: 300 mA	5 J: 90 mA 10 J: 160 mA
Leistungsaufnahme	12-48DC: 4W 24 DC: 2W	4,5 VA	4,5 VA	4,5 VA	8 W	11,5 W	11,5 W	34,5 VA	18,5 VA	25 VA
Einschaltdauer	100%									
Anschlussklemmen	0,14 - 2,5mm <sup>2</sup> feindrähtig / AWG24 - AWG 14 (stranded)									
Schutzart	IP66 (EN60529), Type 4 & 4x									
Schlagfestigkeit	IK08 (EN50102)									
Schutzklasse	II									
Betriebstemperatur	-40°C...+55°C									
Lagertemperatur	-40°C...+70°C									
Max. rel. Luftfeuchte	90%									
Kabeleinführung	6x M20 vorgeprägt				4x M20 vorgeprägt					
Dichtbereich der Durchführungsstülle	7 – 13 mm Bei Verwendung von Kabeldurchmessern < 7mm ist eine Kabelverschraubung mit ausreichender Schutzart vorzusehen									
Gehäusematerial	PC/ABS Blend									
Haubenmaterial	PC									
Einbaulage	beliebig									
Optionen	-SSM (siehe Seite 5)									
Zubehör	Plombierstopfen (Art.-Nr. 28300000002)									
Haubenfarben	klar, weiß, gelb, orange, rot, grün, blau									

## Zulassungen

Zulassungen (gilt für gekennzeichnete Betriebsmittel)																	
Bauproduktverordnung (305/2011/EU)  	<b>VdS 0786-CPD-21182</b>																
	<table border="1"> <thead> <tr> <th colspan="2">PA 5</th> </tr> </thead> <tbody> <tr> <td>Optionen</td> <td>-SSM (24V DC)</td> </tr> <tr> <td>Bemessungsspannung</td> <td>24 – 48 V DC</td> </tr> <tr> <td>Spannungsbereich gemäß EN54-3</td> <td>18V – 57V Option: -SSM (18V – 30V)</td> </tr> <tr> <td>Ton</td> <td>konform zur Bauproduktenrichtlinie (89/106/EWG) 1200Hz-500Hz (Sägezahn/ Saw tooth) DIN/PFEER P.T.A.P. 500Hz-1200Hz (Ansteigender Ton/ Slow whoop) 825Hz (Dauerton/ Continuous) 660Hz (Unterbrochener Ton/ Intermittent) 800Hz/ 1000Hz (Wechselton/ Alternating) 544Hz/ 440Hz (NF S 32-001)</td> </tr> <tr> <td>Signalisierungsbereich</td> <td>EN54-3: siehe Dokument 30304-005-1</td> </tr> <tr> <td>Umweltschutzklasse</td> <td>Typ B</td> </tr> <tr> <td colspan="2">Die Prüfung erfolgte unter Verwendung des mitgelieferten Membrannippels und der äußeren Befestigungsbohrungen.</td> </tr> </tbody> </table>	PA 5		Optionen	-SSM (24V DC)	Bemessungsspannung	24 – 48 V DC	Spannungsbereich gemäß EN54-3	18V – 57V Option: -SSM (18V – 30V)	Ton	konform zur Bauproduktenrichtlinie (89/106/EWG) 1200Hz-500Hz (Sägezahn/ Saw tooth) DIN/PFEER P.T.A.P. 500Hz-1200Hz (Ansteigender Ton/ Slow whoop) 825Hz (Dauerton/ Continuous) 660Hz (Unterbrochener Ton/ Intermittent) 800Hz/ 1000Hz (Wechselton/ Alternating) 544Hz/ 440Hz (NF S 32-001)	Signalisierungsbereich	EN54-3: siehe Dokument 30304-005-1	Umweltschutzklasse	Typ B	Die Prüfung erfolgte unter Verwendung des mitgelieferten Membrannippels und der äußeren Befestigungsbohrungen.	
	PA 5																
	Optionen	-SSM (24V DC)															
	Bemessungsspannung	24 – 48 V DC															
	Spannungsbereich gemäß EN54-3	18V – 57V Option: -SSM (18V – 30V)															
	Ton	konform zur Bauproduktenrichtlinie (89/106/EWG) 1200Hz-500Hz (Sägezahn/ Saw tooth) DIN/PFEER P.T.A.P. 500Hz-1200Hz (Ansteigender Ton/ Slow whoop) 825Hz (Dauerton/ Continuous) 660Hz (Unterbrochener Ton/ Intermittent) 800Hz/ 1000Hz (Wechselton/ Alternating) 544Hz/ 440Hz (NF S 32-001)															
Signalisierungsbereich	EN54-3: siehe Dokument 30304-005-1																
Umweltschutzklasse	Typ B																
Die Prüfung erfolgte unter Verwendung des mitgelieferten Membrannippels und der äußeren Befestigungsbohrungen.																	
VdS	<b>G 212115</b> Daten siehe Bauproduktverordnung (305/2011/EU)																
GL	<b>61062-13 HH</b> Umweltkategorie C, H, EMC1																
MED	<b>61739-14 HH</b>																
CNBOP	PA 5: <b>2015/2014</b>																
UL, cUL	UCST, UCST7, ULSZ, ULSZ7, UEES, UEES7 (weiterführende Informationen siehe Seite 7)																

## Inbetriebnahme

### Sicherheitshinweise:

- Der elektrische Anschluss darf nur von hierfür autorisierten Personen in Übereinstimmung mit den derzeit gültigen Vorschriften durchgeführt werden.
  - Warnung vor gefährlicher hoher elektrischer Spannung.
  - Vor dem Öffnen ist sicherzustellen, dass das Gerät nicht unter Spannung steht.
  - Vor Inbetriebnahme ist die auf dem Typenschild angegebene Versorgungsspannung zu kontrollieren. Eine falsche Betriebsspannung kann zur Schädigung bzw. zur Zerstörung des Betriebsmittels führen.
  - Bei der Installation ist darauf zu achten, dass die Anschlussleitung gegen Zug und Verdrehen abgesichert ist. Bitte beachten: Die Geräte sind nicht für einen ortsveränderlichen Einsatz bestimmt. - **WARNUNG:** Bei Installation Verdrahtung entfernt von scharfen Kanten, Ecken und internen Komponenten.
  - Die Öffnung des Schalltrichters darf insbesondere bei Verwendung im Außenbereich oder in staubreicher Umgebung nicht nach oben zeigen.
  - Die Funktion des Gerätes ist nur gewährleistet, wenn Ober- und Unterteil korrekt zusammengefügt sind.
- Bei Verwendung der Kombination mit der Leuchte (PA X 5-05/ PA X 5-10):
- Um eine Beeinträchtigung des Sehvermögens zu verhindern, ist der dauernde, direkte Blick in die aktivierte Leuchte zu vermeiden.

### Öffnen des Gehäuses:

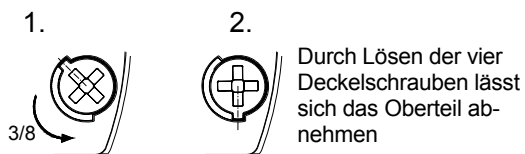

### Verschließen des Gehäuses

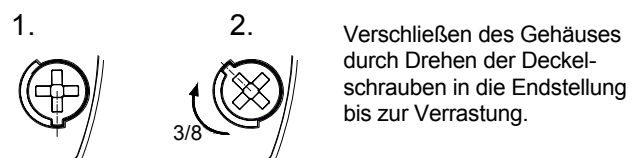

Das Gerät wird in nicht verschlossenem Zustand ausgeliefert.  
Plombierstopfen für die Gehäuseschrauben sind als Zubehör erhältlich.

### Kabeldurchführungen

Zur Sicherstellung der angegebenen Schutzart sind an den dafür vorgesehenen Durchbrüchen Kabeldurchführungen mit einer Schutzart von IP 66 zu montieren. Der mitgelieferte Membrannippel kann durch eine Kabelverschraubung oder durch einen M12-Steckverbinder mit einem Flanschmaß von M20 ersetzt werden.

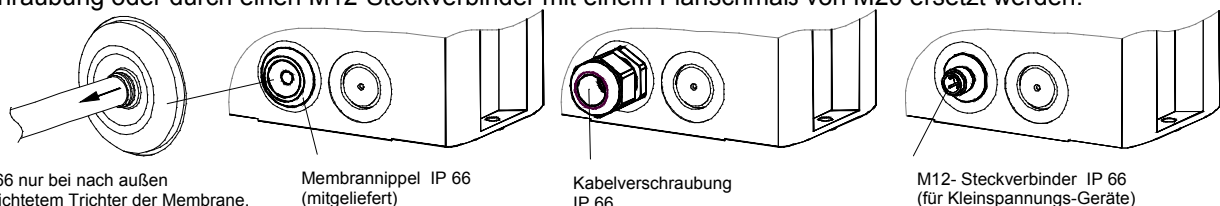



## Änderung der Töne durch externe Ansteuerung

Für Anwendungen, die zusätzlich zum Grundton weitere Töne benötigen, besteht die Möglichkeit, bis zu drei weitere Tonarten mithilfe der folgenden elektrischen Ansteuerungen zu erreichen. Grundsätzlich wird erst der gewünschte Grundton ♪ (siehe Tonartentabelle im Anhang) mit dem Tonartenschalter S3 auf der Treiberplatine eingestellt. Die korrespondierenden zusätzlichen Töne (C1, C2, C1+C2) sind der Tabelle „Ansteuerung der Töne“ im Anhang zu entnehmen.

### Tonstufenauswahl durch Steuereingang (TAS)

#### DC-Version:

Bei polrichtiger Anwendung erfolgt die Tonauswahl über die Steuereingänge C1 und C2 auf der Anschlussplatine. Die Versorgungsspannung muss dabei immer zusammen mit den Steuereingängen angelegt werden. Schalterstellung S1A auf der Treiberplatine:  (Diode nicht überbrückt). Über den Umschalter S1B auf der Treiberplatine erfolgt die Auswahl der Polarität der Steuerspannung („+“ oder „-“).

„+“: positive Ansteuerung

„-“: negative Ansteuerung (Werkseinstellung)

**Achtung:** Ist die Steuerspannung größer als die Versorgungsspannung oder die Versorgungsspannung liegt nicht an, erfolgt die Betriebsstromversorgung über die Steuereingänge. Eine entsprechende Belastbarkeit muss dann gewährleistet sein.

#### AC-Version:

In der AC-Version erfolgt die Tonauswahl durch Anschließen der Phase „L“ der Versorgungsspannung an die Steuereingänge C1 bzw. C2. Die Versorgungsspannung muss dabei immer zusammen mit den Steuereingängen angelegt werden.

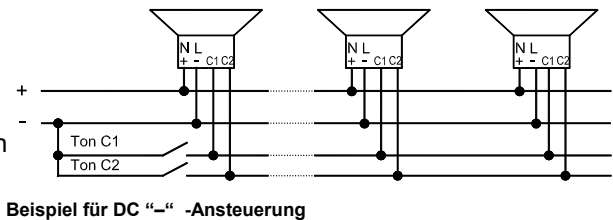
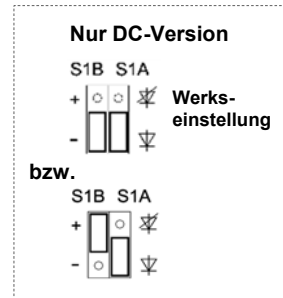
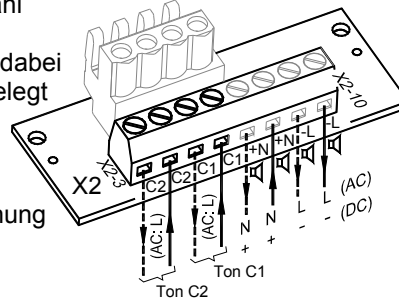

### Tonstufenauswahl durch Versorgung über Steuereingang (TAV) - für alle DC-Versionen

Der Schallgeber kann über die Steuereingänge C1 bzw. C2 auf der Anschlussplatine mit Betriebsspannung versorgt werden. Versorgung und Tonstufenauswahl erfolgt somit gleichzeitig.

Der Minuspol des Schallgebers muss angeschlossen sein. Durch Anschließen der positiven Spannung an den Pluspol der Anschlussplatine wird der Grundton (♪) erzeugt; durch Anschluss an C1 bzw. C2 wird die entsprechende Tonstufe ausgewählt.

Durch gleichzeitiges Anschließen der positiven Spannung an C1 und C2 wird die Tonstufe „C1+C2“ gewählt. Der Umschalter S1B auf der Treiberplatine muss auf „+“ stehen.

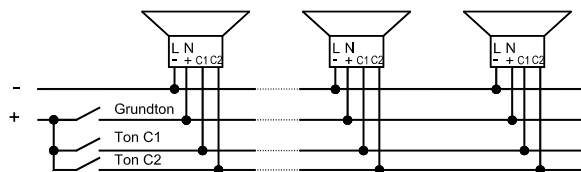
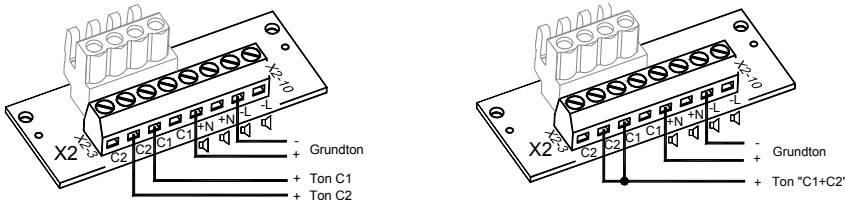

Anschlussbeispiel

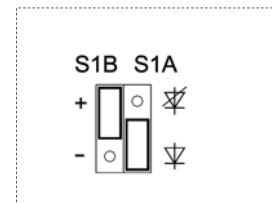

### Tonstufenauswahl durch Verpolung (TAR) - für alle DC-Versionen (außer Option –SSM)

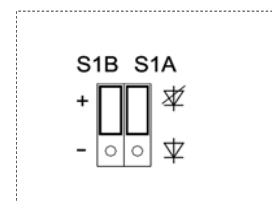
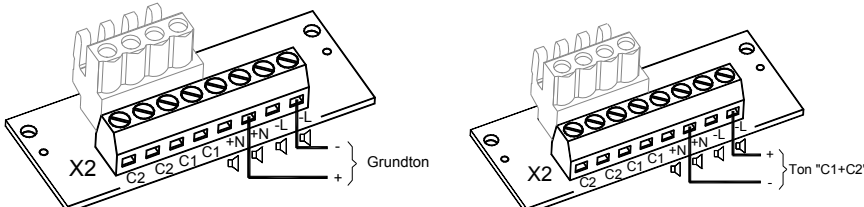

Bei Schalterstellung S1A auf  (Diode überbrückt) auf der Treiberplatine, kann durch Verpolung der Betriebsspannung zum Grundton (♪) zusätzlich Ton „C1+C2“ gewählt werden. Der Umschalter S1B muss auf „+“ geschaltet werden.

**Die Steuereingänge C1 und C2 dürfen auf der Anschlussplatine nicht beschaltet werden.**



## Option –SSM (Soft-Start-Modul) (nur 24V DC):

Begrenzung der Einschaltstromspitze auf:

<b>PA 5-SSM:</b>	 : max. 2,1 A	
<b>PA X 5-xx-SSM:</b>	 : max. 2,1 A	 : max. 4,5 A

- Durchschalten der Betriebsspannung zum Betriebsmittel erst ab >7V.
- Widerstand zur Leitungsüberwachung angeschlossen.

Betriebsspannungsbereich: 18V – 30V DC

## Widerstand zur Leitungsüberwachung:

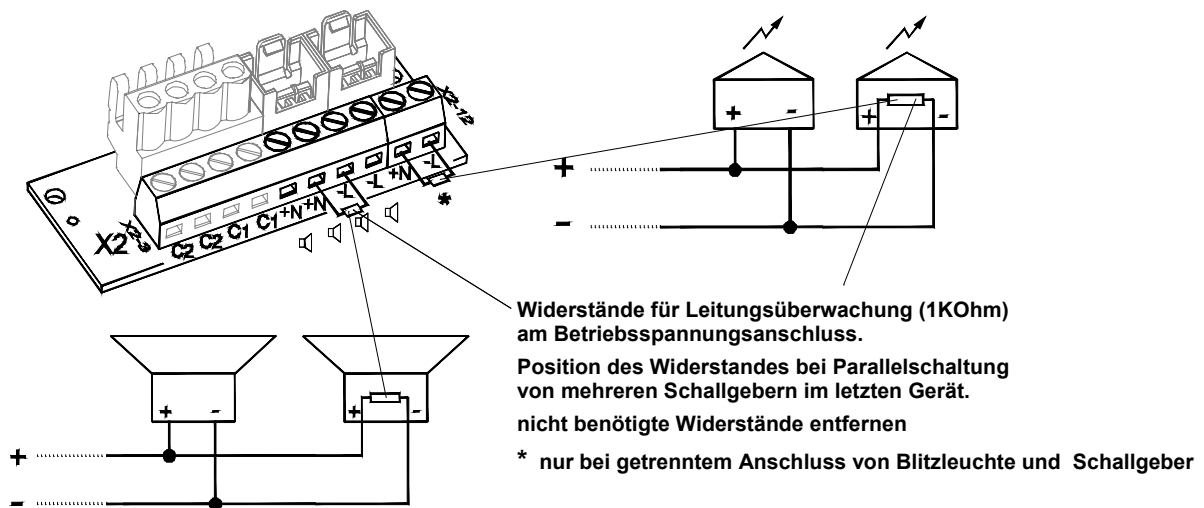

## Wartung, Service, Instandhaltung

Das Gerät erfordert keine besondere Wartung. Die äußere Reinigung sollte mit einer schwachen Seifenlösung ohne Verwendung von Lösungsmittel erfolgen. Der Schallgeber darf nur in unbeschädigtem Zustand innerhalb der spezifizierten Kenndaten betrieben werden. Umbauten, Änderungen, fehlerhafter und unzulässiger Einsatz sowie die Nichtbeachtung der Hinweise dieser Betriebsanleitung schließen eine Gewährleistung aus. Ein Austausch von Komponenten darf nur mit Originalersatzteilen erfolgen. Reparaturen sind grundsätzlich im Herstellerwerk auszuführen.

# PA 5 / PA X 5-05/ PA X 5-10 - Operating and installation instruction

## Dimensions

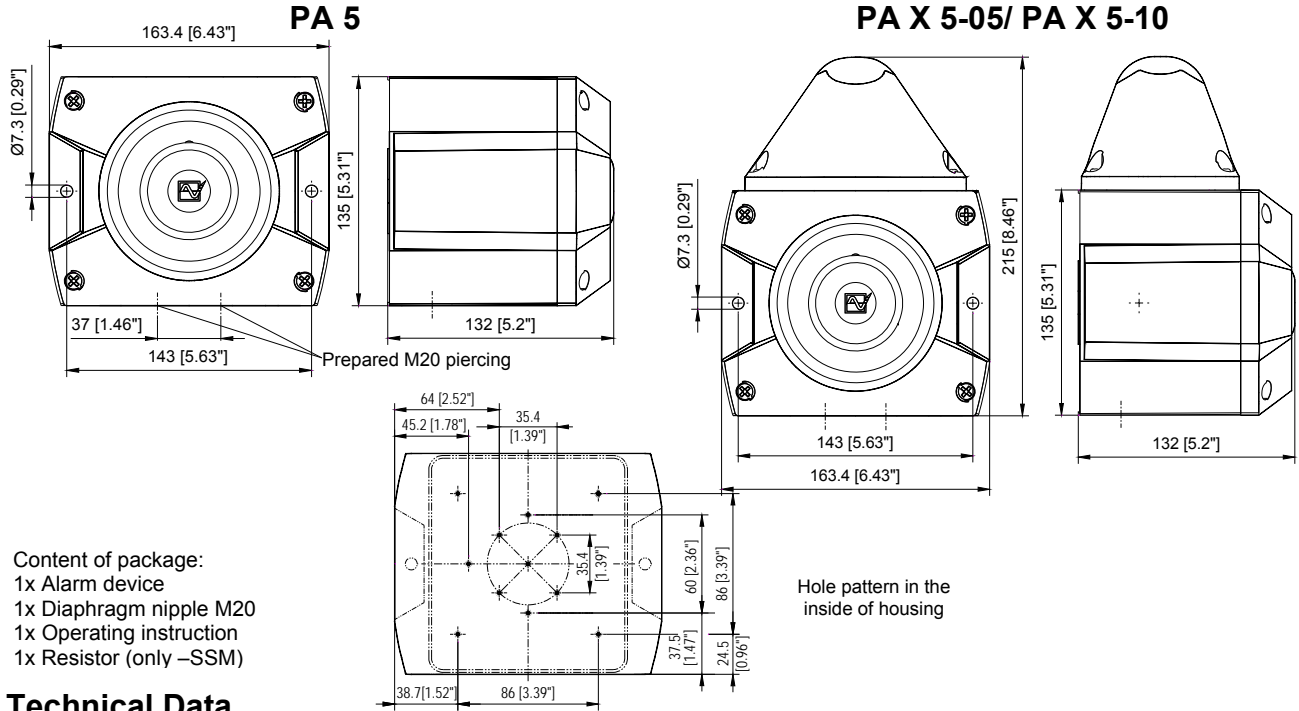

## Technical Data

		PA 5				PA X 5-05/ PA X 5-10					
Nom. sound level	105dB (A) 1m										
Volume control	max. -12dB										
Tones	80										
Flash energy	-				PA X 5-05: 5J			PA X 5-10: 10J			
Flash frequency	1Hz										
Rated voltage (limits see approvals)	24V DC or 12 – 48 V DC	24V AC 50/60 Hz	115V AC 50/60 Hz	230V AC 50/60 Hz	12V DC	24V DC	48V DC	24V AC 50/60 Hz	115V AC 50/60 Hz	230V AC 50/60 Hz	
Operating voltage range	10 - 57 V DC	18-30 V AC	95 – 127 V AC	195 – 253 V AC	10-15 V DC	18-30 V DC	40-57 V DC	18-30 V AC	95 – 127 V AC	195 – 253 V AC	
Current consumption Sounder (max)	80 mA	150 mA	30 mA	16 mA	25 mA	70 mA	80 mA	150 mA	30 mA	16 mA	
Current consumption Beacon (max)	-	-	-	-	5 J: 700 mA 10 J: 1400 mA	5J: 360 mA 10 J: 680 mA	5 J: 170 mA 10 J: 300 mA	5 J: 800 mA 10 J: 1400 mA	5 J: 120 mA 10 J: 300 mA	5 J: 90 mA 10 J: 160 mA	
Power consumption	12-48DC: 4W 24 DC: 2W	4,5 VA	4,5 VA	4,5 VA	8 W	11,5 W	11,5 W	34,5 VA	18,5 VA	25 VA	
Duty cycle	100%										
Connection terminal	0,14 - 2,5mm <sup>2</sup> / AWG24 - AWG 14 (stranded)										
Ingress protection	IP66 (EN60529), Type 4 & 4x										
Resistance against impact	IK08 (EN50102)										
Protection class	II  Double insulated equipment										
Operating temperature	-40°C...+55°C										
Storage temperature	-40°C...+70°C										
Max. rel. Humidity	90%										
Cable entry	6x M20 (prepared)					4x M20 (prepared)					
Sealing range of grommet	7 – 13 mm With the use of cable diameters < 7mm, a cable screw joint with sufficient ingress protection must be provided										
Material of housing	PC/ABS Blend										
Material of lens	PC										
Installation position	arbitrary										
Options	-SSM (see page 11)										
Accessory	Sealing plug (Art-no. 28300000002)										
Lens colours	clear, white, yellow, amber, red, green, blue										

# Approvals

Approvals (valid for marked equipment)				
Construction Product Regulation (305/2011/EC)  	<b>VdS 0786-CPD-21182</b>			
			<b>PA 5</b>	
	Options		-SSM (24V DC)	
	Rated voltage		24 – 48 V DC	
	Operating voltage range acc. to EN54-3, EN54-23		18V – 57V Option: -SSM (18V – 30V)	
	Tone		Compliant with the Construction Product Directive (89/106/EWG) 1200Hz-500Hz (Saw tooth) DIN/PFEER P.T.A.P. 500Hz-1200Hz (Slow whoop) 825Hz (Continuous) 660Hz (Intermittent tone) 800Hz/ 1000Hz (Alternating tone) 544Hz/ 440Hz (NF S 32-001)	
	Signaling area		EN54-3: see document 30304-005-1	
	Environmental protection class		Type B	
Testing takes place using the supplied diaphragm nipple and the outer fastening bores.				
VdS	<b>G 212115</b> Data see Construction Product Regulation (305/2011/EC)			
GL	<b>61062-13 HH</b> Environmental Category C, H, EMC1			
MED	<b>61739-14 HH</b>			
CNBOP	PA 5: <b>2015/2014</b>			
UL, cUL		Rated voltage	Audible-signal Appliance Fire Alarm Equipment ULSZ, ULSZ7	Audible and Visual signal Appliance General Signal Equipment UCST, UCST7 and UEES, UEES7
	<b>PA 5</b>	24V – 48V DC (Fire Alarm Equipment) 12V – 48V DC (General Signal Equipment)	x Special application, limited operating voltage range 18 – 57V DC	-
	<b>PA 5</b> <b>PA X 5-05</b> <b>PA X 5-10</b>	24V AC (except PA X 5-10) 115V AC 230V AC	-	x
	<b>PA X 5-05</b>	12V DC 24V DC 48V DC	-	x

PATROL sounders and combined units **PA 5/ PA X 5** comply with the limits for a Class B digital device, pursuant to part 15 of the FCC Rules.

## UL/ cUL specifications:

Suitable for indoor and outdoor use. Signaling area: see document 30304-005-1.

### Cable gland entries:

Conduit installation needs to be UL/ cUL listed fittings suitable for knockout openings. The supply wiring has to be enclosed in metal conduits for products for Fire Alarm Use.

According to CSA-C22.2 No. 205-M1983 clause 4.3.4 the connection is limited to max. seven leads for combined units (PA X).

### Installation:

The units shall be installed indoors or outdoors in accordance with the manufacturer's installation instructions as well as the National Electrical Code (NFPA 70) and the National Fire Alarm Code (NFPA 72) for the units evaluated for Public Fire Alarm applications in the U.S. In Canada, they shall be installed in accordance with the Canadian Electrical Code, Part 1 and the Standard for the Installation of Fire Alarm Systems CAN/ULC-S524-M91 for the units evaluated for Public Fire Alarm applications. The installation shall also be in a manner acceptable with the local authority having jurisdiction.

For audible application for Fire Alarm Service use both terminals for connection. Break wire run to provide Electrical Supervision (see UL 464 clause 39.1e). The tone no. 111 is to be used for evacuation use only (see UL 464 clause 39.1e)

### cUL directional characteristics for the horn:

AXIS	ANGLE	dB(A)
Horizontal	40 deg. left or right	-3
Horizontal	27 deg. left or right	-6
Vertical	45 deg. left or right	-3
Vertical	27 deg. left or right	-6

### Min. Output sound pressure level: [dB(A)]

Type	Voltage	UL 464 db(A) at 10 ft ++	CAN/ULc-S525-07
PA 5-24V DC	18V DC	76,7 (for tone 111)	86,2 (for tone 60)
Tone no. 2, 15, 60, 104, 131, 146, 111, 112, and 113 was used for this test.			

### Connecting cables:



## Taking into operation

### Safety notes:

- Installation must be carried out by an electrician in compliance with the latest codes and regulations.
- Danger: High voltage may be present.
- Prior to opening, it must be ensured that no voltage is applied to the device.
- Before electrical connection, the supply voltage on the type plate is to be checked. The wrong operating voltage can lead to damages or to the destruction of the equipment.
- During installation it must be ensured that the connection cables are secured against tension and distortion. Please observe: The devices are not designed for portable use.
- CAUTION: When making installation, route field wiring away from sharp projections, corners and internal components.
- The opening of the bell mouth must not point upwards, especially in the case of use outdoors or in a particularly dusty environment.
- The function of the unit is only guaranteed if the upper and lower section is joined correctly.

When using the sounder –beacon combination (PA X 5-05/ PA X 5-10):

- In order to prevent detriment to sight, continuously looking directly in the activated light is to be avoided.

### Opening the housing:

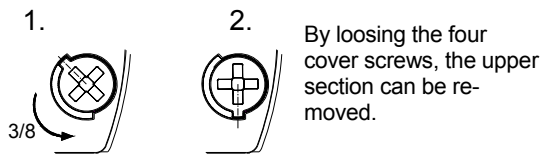

By loosening the four cover screws, the upper section can be removed.

### Closing the housing

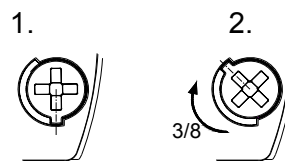

The housing is closed by turning the cover screws to the limit position until the housing locks into place.

The unit is not closed when delivered.

Sealing plugs for the housing screws are available as accessories.

After installation of the cable remove the remains of the diaphragm.

### Cable gland entries

To guarantee the specified protection type, cable grommets with a protection type of IP 66 are to be installed at the openings provided for this purpose. The supplied diaphragm nipple can be replaced with a cable gland or with an M12 plug connection with a flange measurement of M20.

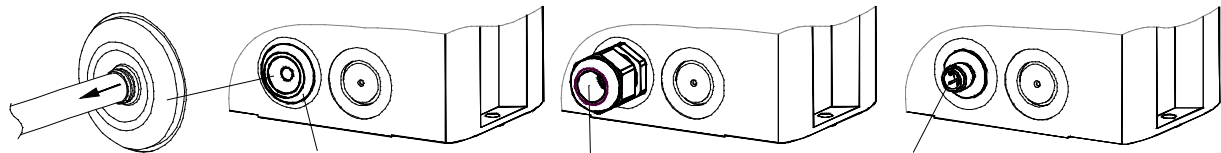

IP 66 only when funnel of membrane is pointing outward.  
After installation of the cable remove the remains of the diaphragm.

Diaphragm nipple IP 66 (provided)

Cable gland IP 66

M12 plug connector IP 66 (for low voltage versions)

### Circuit board for electrical connection (located in the base section):

### Electrical connection and tone selection using external control C1 and C2

#### Terminal for operating voltage - Sounder:

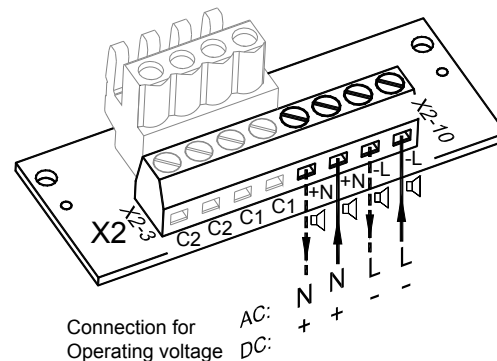

Connection for  
Operating voltage

AC:  
DC:



Terminal for operating voltage - Sounder-beacon combination:

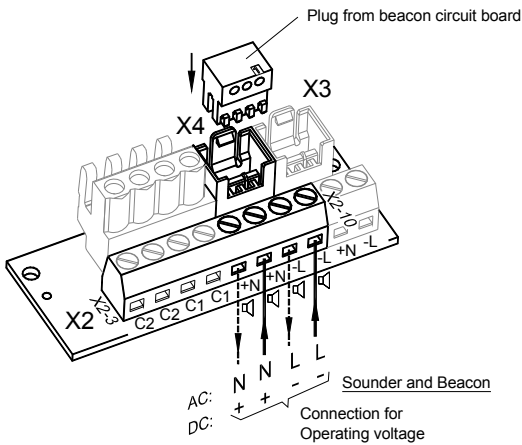

Common connection of beacon and sounder (Delivery status)

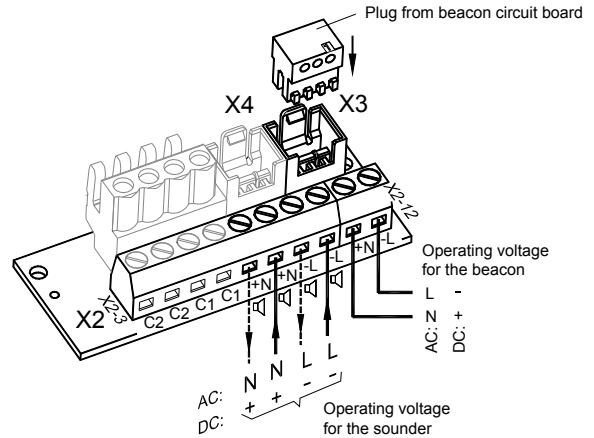

Separate connection of beacon and sounder

The desired tone can be selected using the tone selector switch S3 (on the driver circuit board). The available tones are described in the tone table in the appendix. After establishing the supply voltage the tone is generated.

**Driver circuit board of sounder (located in the upper section):**

**AC-Version**

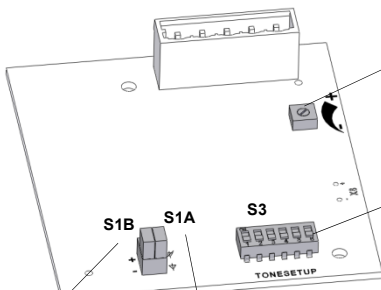

**DC-Version**

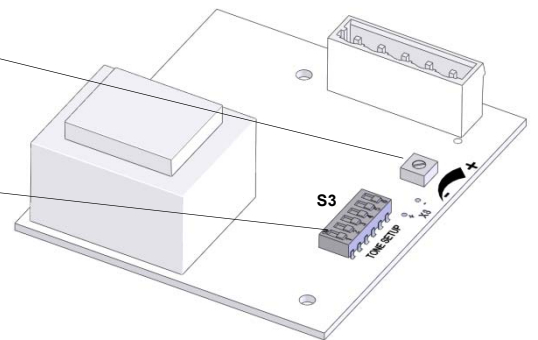

Volume control  
Note:  
To be EN54-3 compliant, the volume control has to be set to the maximum position.

Tone selector switch

**S1B**  
Selection of polarity of the control voltage for C1 and C2

**S1A**  
Bridging of blocking diode

	Diode not bridged Negative polarity <b>Factory setting</b>
	Diode not bridged Positive polarity
	Diode bridged Negative polarity
	Diode bridged Positive polarity

## Change of the tones by external control

For applications which require more tones than just the base tone, it is possible to provide up to three additional tone types with the use of the following electrical controls.

As a basic rule, the desired base tone (♩, see tone table in the appendix) is set with the tone selector switch S3 on the driver board. The corresponding additional tones (C1, C2, C1+C2) can be gathered from the table "Selection of the tones".

### Tone selection with control input (TAS)

#### DC-Version:

When used with correct polarity, the tone selection takes place through the control inputs C1 and C2 on the circuit board. In the process, the supply voltage must always be applied together with the two control inputs. Switch S1A on the driver board is set to  $\nabla$  (Diode not bridged).

The selection of the polarity of the control voltage ("+" or "-") takes place with the switch S1B on the driver board.

"+": positive control

"-": negative control (factory setting)

**Caution:** If the control voltage is greater than the supply voltage or the supply voltage is not applied, the operating current supply is provided through the control inputs. A corresponding load capacity must then be guaranteed.

#### AC-version:

In the AC version the tone selection takes place by connecting the phase "L" of the supply voltage to the control inputs C1 and C2. In the process, the supply voltage must always be applied together with the two control inputs.

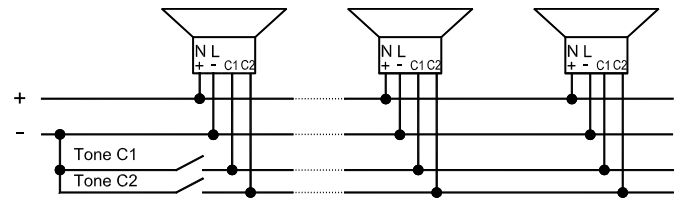
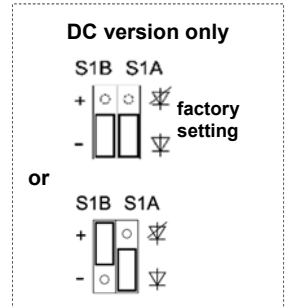
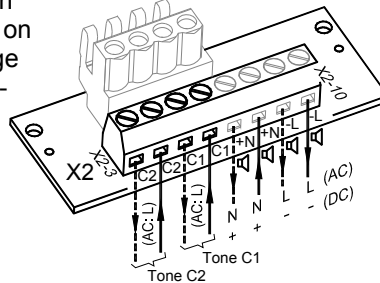

Example for DC "-" -control

### Tone selection with supply through control input (TAV) - for all DC versions

The sounder can be supplied with operating voltage through the control inputs C1 and C2 on the circuit board. Supply and tone selection thus take place simultaneously.

The minus pole of the sounder must be connected. With connection of the positive voltage to the plus pole of the circuit board, the base tone (♩) is generated; with connection to C1 or C2 the corresponding tone is selected.

With simultaneous connection of the positive voltage to C1 and C2 the tone "C1+C2" is selected.

The switch S1B on the driver board must be set to "+".

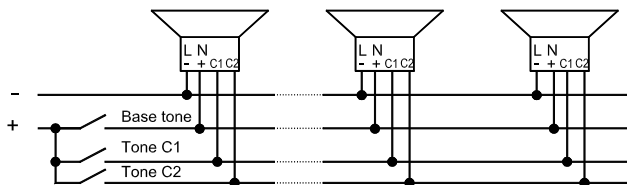
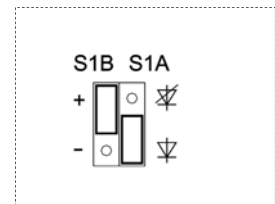
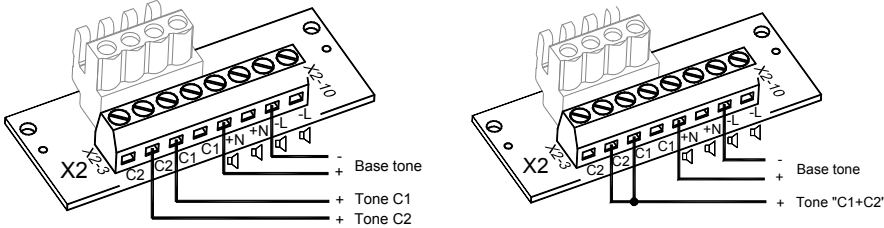

Connection example

### Tone selection through pole reversal (TAR) - for all DC versions, except for option -SSM

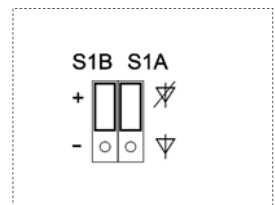
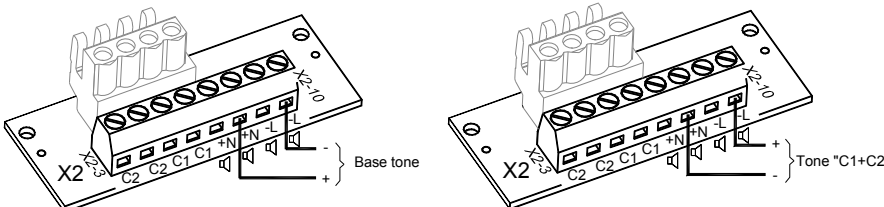

If the switch S1A on the driver board is set to  $\nabla$  (diode bridged), the tone "C1+C2" can be selected in addition to the base tone through pole reversal. The switch S1B must be set to "+".

The control inputs C1 and C2 may not be switched on the circuit board.



**Option –SSM (Soft-Start-Module) (24V DC only):**

- Limiting of the switch-on current peak to:

<b>PA 5-SSM:</b>	 : max. 2,1 A	
<b>PA X 5-xx-SSM:</b>	 : max. 2,1 A	 : max. 4,5 A

- Connection of the operating voltage to the equipment starts at >7V
- Resistance for the line monitoring mounted

Operating voltage range: 18V – 30V DC

**Connection of a resistor for line monitoring:**

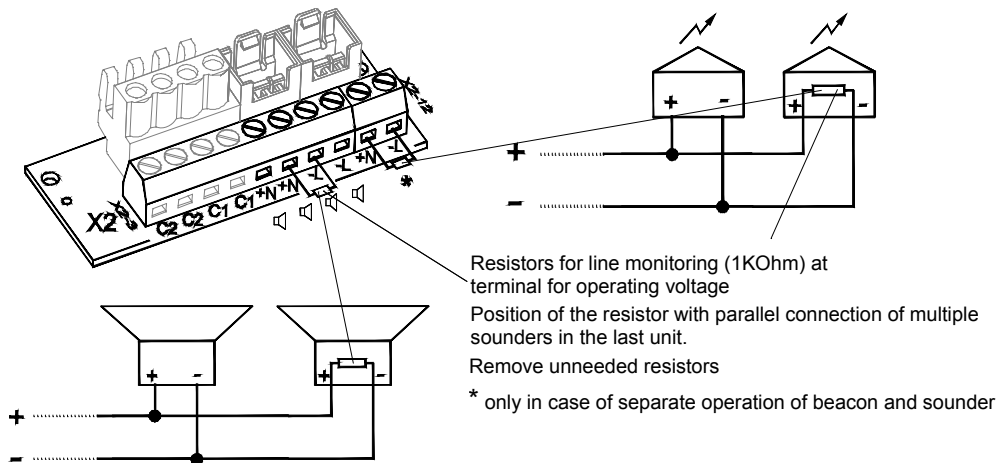

**Maintenance, Service and Ordering Spare Parts**

The device does not require any special maintenance.

External cleaning should be done with a mild soap solution without the use of solvents.

The device may only be operated in the undamaged state within the specified rating.

Conversions, alterations, improper and inadmissible use as well as the non-observance of the notes in these operating instructions shall render the warranty null and void.

Components may be replaced only by original spare parts.

As a matter of principle, repairs are to be carried out in the manufacturing works.

# PA 5 / PA X 5-05/ PA X 5-10 - Instructions d'utilisation et de montage

## Dimensions

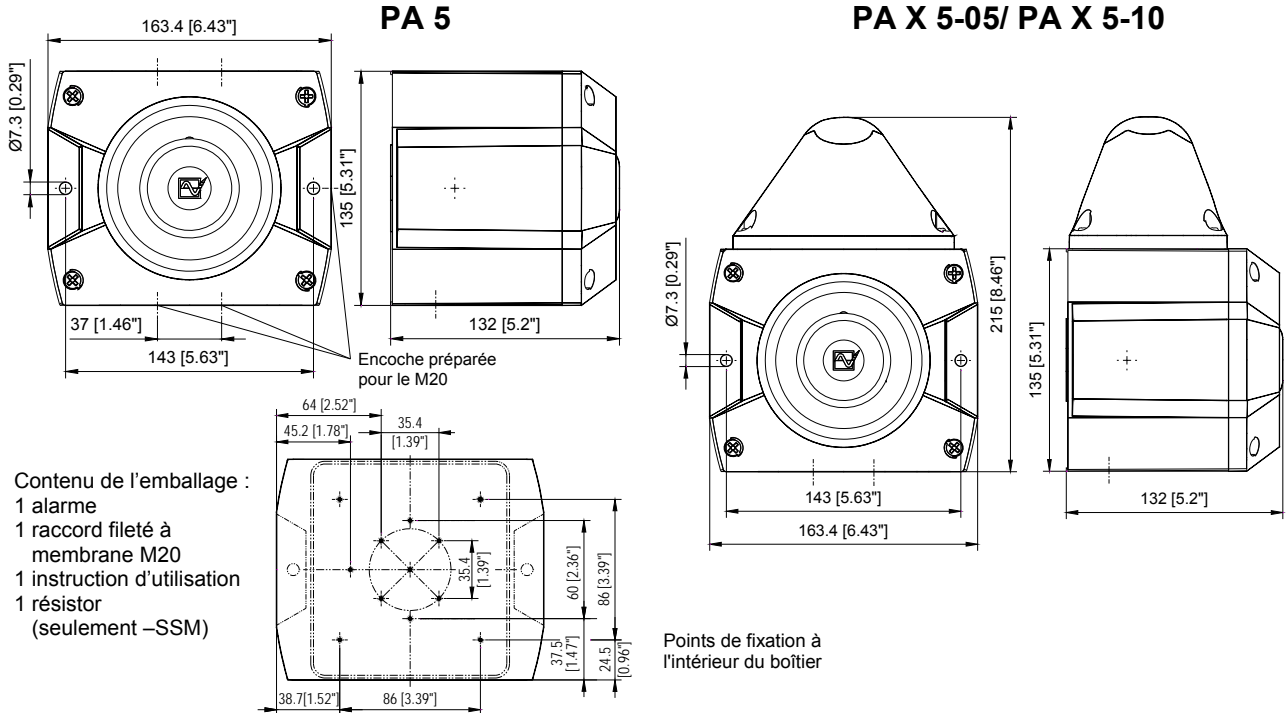

## Caractéristiques techniques

	PA 5				PA X 5-05/ PA X 5-10					
Niveau sonore nominal	105dB (A) 1m									
Réglage du volume sonore	max. -12dB									
Sons	80									
Puissance lumineuse	-				PA X 5-05: 5J / PA X 5-10: 10J					
Fréquence du flash	-				1Hz					
Tension de service (Limitations voir admissions)	24V CC ou 12 - 48 V CC	24V CA 50/60 Hz	115V CA 50/60 Hz	230V CA 50/60 Hz	12V CC	24V CC	48V CC	24V CA 50/60 Hz	115V CA 50/60 Hz	230V CA 50/60 Hz
Plage de la tension de service	10 - 57 V CC	18-30 V CA	95 - 127 V CA	195 - 253 V CA	10-15 V CC	18-30 V CC	40-57 V CC	18-30 V CA	95 - 127 V CA	195 - 253 V CA
Courant nominal (max) admis par la sirène	80 mA	150 mA	30 mA	16 mA	25 mA	70 mA	80 mA	150 mA	30 mA	16 mA
Courant nominal (max) admis par le feu flash	-				5 J: 700 mA	5J: 360 mA	5 J: 170 mA	5 J: 800 mA	5 J: 120 mA	5 J: 90 mA
	-				10 J: 1400 mA	10 J: 680 mA	10 J: 300 mA	10 J: 1400 mA	10 J: 300 mA	10 J: 160 mA
Puissance	12-48V: 4W 24 V: 2W	4,5 VA	4,5 VA	4,5 VA	8 W	11,5 W	11,5 W	34,5 VA	18,5 VA	25 VA
Facteur de marche	100%									
Bornes de connexion	0,14 - 2,5 mm <sup>2</sup> en fils de faible diamètre/ AWG24 - AWG 14 (stranded)									
Type de protection	IP66 (EN60529), Type 4 & 4x									
Résistance aux chocs	IK08 (EN50102)									
Classe de protection	II									
Température de service	-40°C...+55°C									
Température de stockage	-40°C...+70°C									
Humidité relative max.	90%									
Entrée de câbles	6 x M20 avec empreinte préalable				4 x M20 avec empreinte préalable					
Zone d'intensité du profilé de protection	7 - 13 mm		En cas d'utilisation de câbles de diamètre < 7 mm, un raccord de câble équipé d'un type de protection suffisant sera à prévoir							
Matériau du boîtier	Mélange PC/ABS									
Matériau du capot	PC									
Position de montage	quelconque									
Options	-SSM (voir page 16)									
Accessoires	Bouchon de plombier (art. n° 2830000002)									
Couleurs du capot	transparent, blanc, jaune, orange, rouge, vert, bleu									

## Admissions

Admissions (valable pour les appareils signalés)		
Règlement sur les produits de construction (305/2011/CE)  	VdS 0786-CPD-21182	
	<b>PA 5</b>	
	Options	-SSM (24V CC)
	Tension de service	24 – 48 V CC
	Plage de tension de service selon EN54-3	18V – 57V Option: -SSM (18V – 30V)
	Son	Conforme à la Directive sur les produits de construction (89/106/CEE) 1200Hz-500Hz (dent de scie DIN/PFEER P.T.A.P.) 500Hz-1200Hz (son montant) 825Hz (son continu) 660Hz (son interrompu) 800Hz/ 1000Hz (son variable) 544Hz/ 440Hz (NF S 32-001)
	Plage de signalisation	EN54-3: voir document 30304-005-1
	Classe de protection environnementale	Type B
Le test a été effectué en utilisant le raccord fileté de membrane livré et les perçages extérieurs de fixation.		
VdS	<b>G 212115</b> , pour les caractéristiques voir le Règlement sur les Produits de construction (305/2011/CE)	
GL	<b>61062-13 HH</b> Catégorie environnementale C, H, EMC1	
MED	<b>61739-14 HH</b>	
CNBOP	PA 5: <b>2015/2014</b>	
UL, cUL	UCST, UCST7, ULSZ, ULSZ7, UEES, UEES7 (plus d'informations voir page 7)	

## Mise en service

### Consignes de sécurité :

- Le branchement électrique doit être effectué uniquement par des personnes autorisées conformément aux réglementations en vigueur.
  - Attention à la tension électrique élevée. Danger !
  - Avant d'ouvrir, il convient de s'assurer que l'appareil est hors tension.
  - La tension d'alimentation indiquée sur la plaque signalétique doit être vérifiée avant la mise en service. Une tension de service incorrecte peut entraîner un endommagement ou la destruction de l'appareil.
  - Il convient de veiller, lors de l'installation, que les cordons d'alimentation ne sont pas soumis à des contraintes de traction ou de torsion. Attention : les appareils ne sont pas destinés à une utilisation mobile.
  - **AVERTISSEMENT** : lors de l'installation, maintenir les câblages éloignés des bords coupants, coins et composants internes.
  - L'ouverture du pavillon ne doit pas être tournée vers le haut, notamment en cas d'utilisation à l'extérieur ou dans un environnement poussiéreux.
  - Le fonctionnement de l'appareil n'est garanti que si les parties supérieure et inférieure sont assemblées correctement.
- En cas d'utilisation de l'ensemble avec le feu flash (PA X 5-05/ PA X 5-10):
- Pour éviter un risque d'endommagement de l'acuité visuelle, il convient d'éviter le contact visuel direct et permanent avec la lampe.

### Ouverture du boîtier

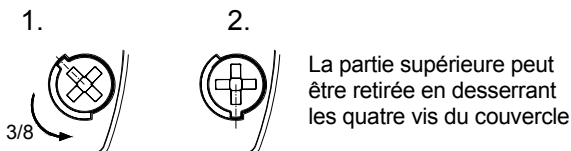

### Fermeture du boîtier

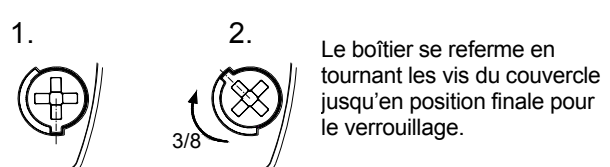

L'appareil est livré en état non verrouillé.

Des bouchons de plombier sont disponibles en accessoires pour les vis du boîtier.

### Passages de câbles

Afin de garantir le type de protection indiqué, des passages de câbles d'une protection IP 66 doivent être montés au niveau des perçages prévus à cet effet. Le raccord fileté à membrane fourni peut être remplacé par un passe-câble à vis ou par un connecteur M12 avec une bride de dimension M20.

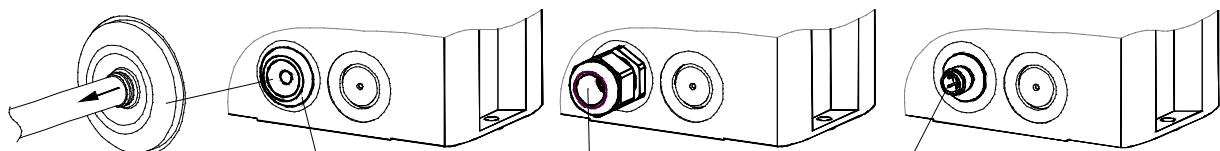

IP 66 uniquement lorsque l'entonnoir de la membrane est orientée vers l'extérieur

Raccord fileté à membrane IP 66 (fourni)

Passe-câble à vis IP 66

Connecteur M12 IP66 pour appareils très basse tension

Après le montage du câble, ôter le reste de la membrane

**Platine de raccordement dans la partie inférieure :  
Branchement électrique et choix de la tonalité par activation externe C1 et C2**

Raccordement à la tension de service de la sirène :

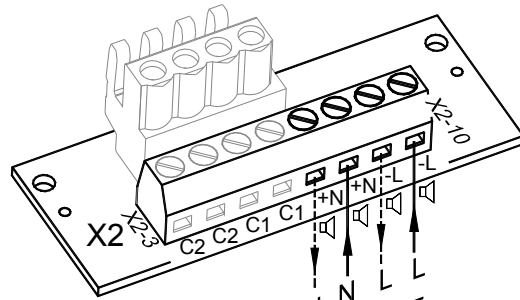

Raccordement à la tension de service  
AC: N L  
DC: + -

Raccordement à la tension de service de l'ensemble sirène-feu flash :

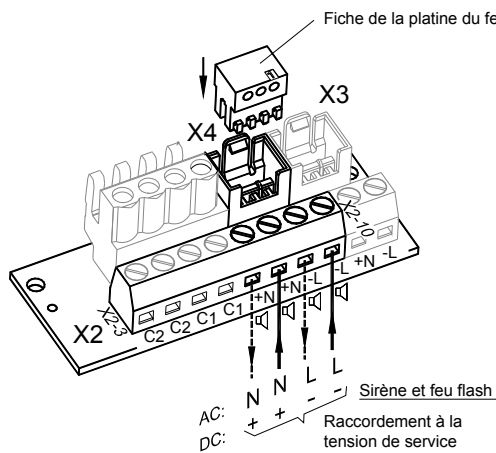

Raccordement commun  
du feu flash et de la sirène  
(État à la livraison)

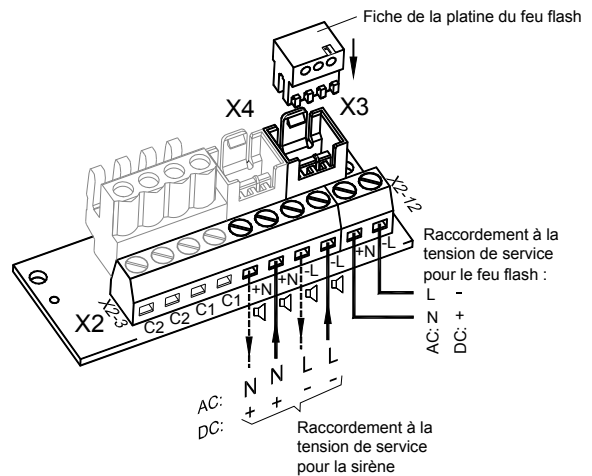

Raccordement séparé  
du feu flash et de la sirène

Le son peut être sélectionné à l'aide de l'interrupteur de tonalité S3 (sur la platine pilote de la partie supérieure).  
Les sons possibles sont décrits dans le tableau des tonalités en Annexe.  
Le son est émis dès que la tension d'alimentation est appliquée.

**Platine pilote de la sirène (partie supérieure) :**

**Version CC**

**Version CA**

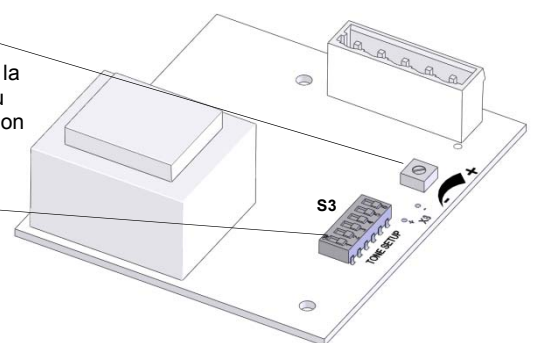
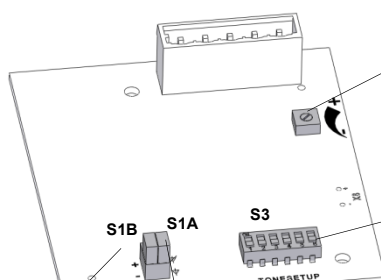

Régulateur du volume  
Remarque :  
Pour rester en conformité avec la norme EN54-3, le régulateur du volume doit se trouver en position maximale

Interrupteur de tonalité

**S1B**  
Sélection de la polarité de la tension de commande pour C1 et C2

**S1A**  
Shunt de la diode de polarité

S1B S1A +	Diode n'est pas pontée Polarité négative <b>Réglage d'usine</b>
S1B S1A +	Diode n'est pas pontée Polarité positive
S1B S1A +	Diode est pontée Polarité négative
S1B S1A +	Diode est pontée Polarité positive

## Modification des sons par activation externe

Pour les applications nécessitant d'autres sons que celle de base, il est possible d'obtenir jusqu'à trois autres sons à l'aide des activations électriques suivantes.

En principe, le son de base souhaitée (♫, voir le tableau des tonalités en annexe) est réglé en premier à l'aide de l'interrupteur de tonalité S3 sur la platine pilote. Les sons supplémentaires correspondants (C1, C2, C1 + C2) figurent dans le tableau « Activation des Sons » en annexe.

### Sélections des tons par entrée de commande (TAS)

#### Version CC :

En cas d'application respectant la polarité, la sélection du son s'effectue par les entrées de commande C1 et C2 sur la platine de raccordement. La tension d'alimentation doit alors toujours être appliquée avec les entrées de commande. Position de l'interrupteur S1A

sur la platine pilote :  (Diode n'est pas pontée)

La sélection de la polarité de la tension de commande (« + » ou « - ») se fait à l'aide du commutateur S1B sur la platine pilote.

« + » : activation positive

« - » : activation négative (réglage usine)

**Attention :** si la tension de commande est supérieure à la tension d'alimentation ou si la tension d'alimentation n'est pas appliquée, l'alimentation de service s'effectue par les entrées de commande. Une capacité correspondante doit alors être assurée.

#### Version CA :

En version CA, la sélection du son s'effectue en reliant la phase « L » de la tension d'alimentation aux entrées de commande C1 ou C2. La tension d'alimentation doit alors toujours être appliquée avec les entrées de commande.

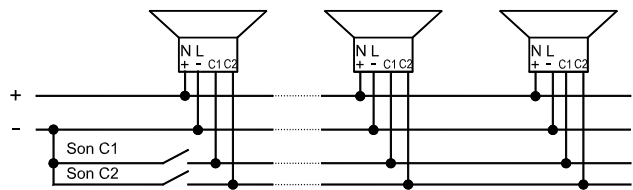
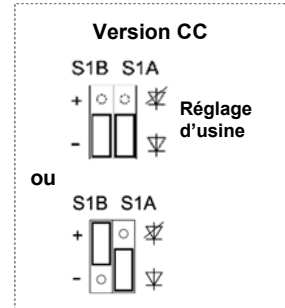
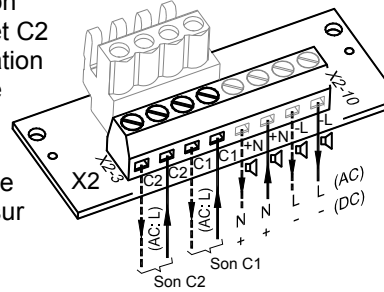

Exemple for DC “-“ -control

### Sélection des tons par alimentation à l'aide de l'entrée de commande (TAV) – pour toutes les versions CC

La sirène peut être alimentée en courant de service par les entrées de commande C1 ou C2 sur la platine de raccordement. L'alimentation et la sélection des tons se font alors simultanément.

Le pôle négatif de la sirène doit être branché. Si la tension positive est branchée sur le pôle positif de la platine de raccordement, le son de base (♫) est émis ; si le branchement est effectué sur C1 ou C2, le ton correspondant est sélectionné.

Lorsque la tension positive est branchée simultanément sur C1 et C2, le ton « C1 + C2 » est sélectionné.

Le commutateur S1B de la platine pilote doit être placé sur « + ».

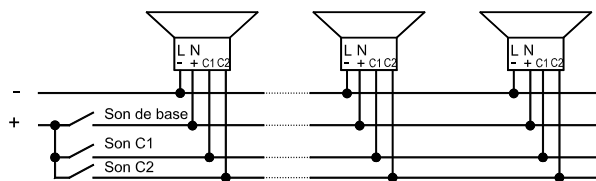
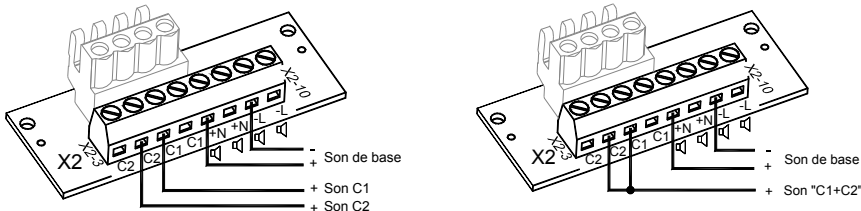

Exemple de raccordement

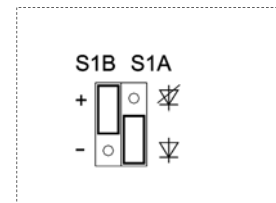

### Sélection des tons par inversion de polarité (TAR) – pour toutes les versions CC

(Cette fonction n'est pas disponible avec les appareils équipés de l'option -SSM)

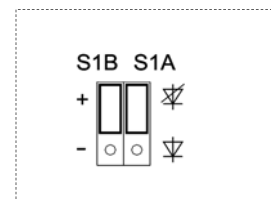
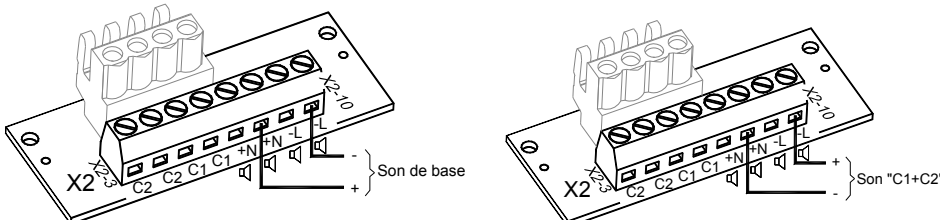

Si position de l'interrupteur S1A (sur la platine pilote) est réglé sur  (diode pontée), le ton « C1 + C2 » peut être sélectionné en plus de la tonalité de base (♫) par inversion de la polarité de la tension de service. Le commutateur S1B doit être positionné sur « + ».

**Les entrées de commande C1 et C2 ne doivent pas être câblées sur la platine de raccordement.**



### Option SSM (Module Soft-Start) (uniquement 24 V CC) :

- Limitation de la pointe du courant à l'enclenchement à :

PA 5-SSM:	 : max. 2,1 A	
PA X 5-xx-SSM:	 : max. 2,1 A	 : max. 4,5 A

- Transfert de la tension de service sur l'équipement à partir de > 7V
- Résistance à la direction des circuits intégrée

Plage de la tension de service : 18 V – 30 V CC

### Résistance pour la surveillance de ligne

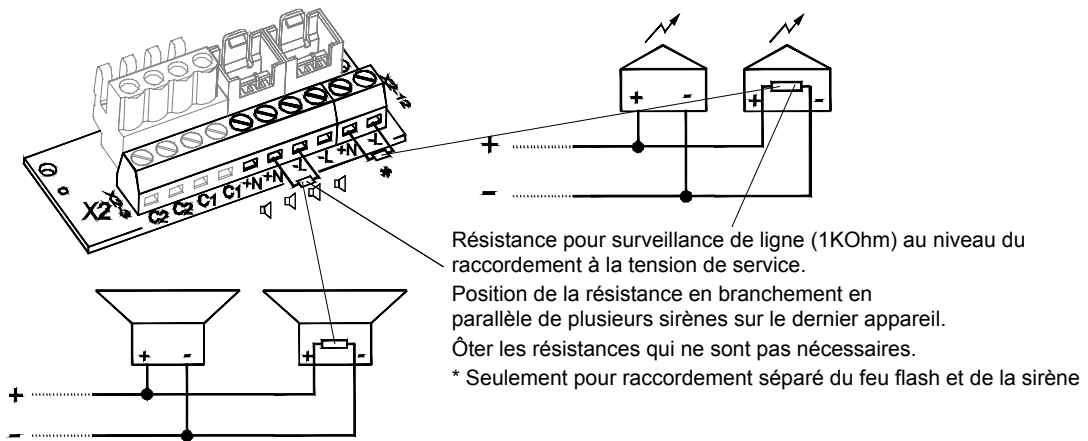

### Maintenance, SAV, entretien

L'appareil ne requiert aucune maintenance particulière. Le nettoyage extérieur doit être effectué avec une solution légèrement savonneuse, sans solvants.

L'appareil doit être exploité uniquement en bon état de marche et dans le respect des caractéristiques indiquées.

Toute transformation, modification, utilisation incorrecte ou inadmissible ainsi que le non-respect des instructions de service entraînent l'exclusion de la garantie.

Tous les composants doivent être remplacés uniquement par des pièces originales. Les réparations doivent en principe être effectuées dans les ateliers du fabricant.



# PA 5 / PA X 5-05/ PA X 5-10 Инструкция по монтажу и эксплуатации

## Размеры

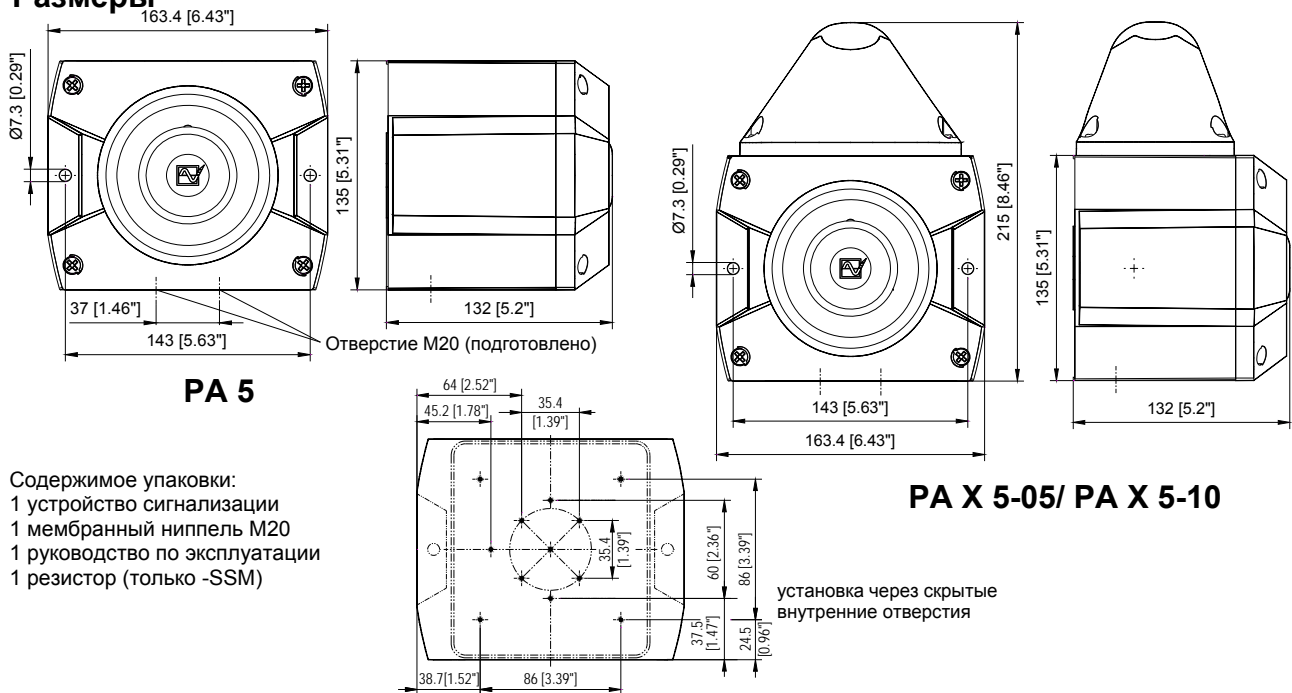

Содержимое упаковки:  
 1 устройство сигнализации  
 1 мембранный ниппель M20  
 1 руководство по эксплуатации  
 1 резистор (только -SSM)

## Технические данные

	PA 5				PA X 5-05/ PA X 5-10					
Ном. уровень звука	105 дБ (А) 1 м									
Регулировка звука	макс. -12 дБ									
Тон	80									
Энергия вспышки	-				PA X 5-05: 5 Дж PA X 5-10: 10 Дж					
Частота вспышки	-				1 Гц					
Рабочее напряжение	24 В DC или 12 – 48 В DC	24В AC 50/60Гц	115 В AC 50/60Гц	230 В AC 50/60Гц	12 В DC	24 В DC	48 В DC	24 В AC 50/60Гц	115 В AC 50/60Гц	230 В AC 50/60Гц
Диапазон рабочего напряжения	10 – 57 В	18-30В	95 – 127В	195–253 В	10-15 В	18-30 В	40-57 В	18-30 В	95 – 127В	195–253 В
Номинальный ток, потребляемый излучателем звука (Макс)	80 мА	150 мА	30 мА	16 мА	25 мА	70 мА	80 мА	150 мА	30 мА	16 мА
Номинальный ток, потребляемый проблесковой лампой (Макс)	-	-	-	-	5 Дж: 700 мА 10 Дж: 1400 мА	5 Дж: 360 мА 10 Дж: 680 мА	5 Дж: 170 мА 10 Дж: 300 мА	5 Дж: 800 мА 10 Дж: 1400 мА	5 Дж: 120 мА 10 Дж: 300 мА	5 Дж: 90 мА 10 Дж: 160 мА
Мощность	12-48DC: 4 вт 24 DC: 2 вт	4,5 ВА	4,5 ВА	4,5 ВА	8 вт	11,5 вт	11,5 вт	34,5 ВА	18,5 ВА	25 ВА
Рабочий цикл	100%									
Соединения	0,14 - 2,5 мм <sup>2</sup> , с тонким проводом / AWG24 - AWG 14 (многожильное)									
Тип защиты	IP66 (EN60529), Type 4 & 4x									
Ударная прочность	IK08 (EN50102)									
Класс защиты	II									
Рабочая температура	-40°C...+55°C									
Температура хранения	-40°C...+70°C									
Макс. отн. влажность воздуха	90%									
Кабельный ввод	M20, 6 шт, предварительно подготовлены				M20, 4 шт, предварительно подготовлены					
Допустимый диаметр кабеля	7 – 13 мм; при использовании кабеля диаметром менее 7 мм должна применяться резьбовая втулка с соответствующим классом защиты									
Материал корпуса	Поликарбонат/акрилонитрил-бутадиен-стирол									
Материал линзы	Поликарбонат									
Монтажное положение	Произвольное									
Опции	-SSM (см. стр. 21)									
Аксессуары	Пломбировочные пробки (арт. 28300000002)									
Цвет линзы					прозрачная, белый, жёлтый, оранжевый, красный, зелёный, синий					

## Допуски

Допуски (только для оборудования с маркировкой)		
Директива Европейского Союза по строительным изделиям (305/2011/EC)  	VdS 0786-CPD-21182	
	Опции	-SSM (24 В DC)
	Рабочее напряжение	24 – 48 В пост.тока
	Диапазон рабочего напряжения согласно EN54-3, EN54-23	18 – 57 В Опция: -SSM (18 – 30 В)
	Тональность	Согласно Директиве ЕС по строительным изделиям (89/106/EWG) 1200-500 Гц (звук пилы DIN/PFEER P.T.A.P.) 500-1200 Гц (с повышением тональности) 825 Гц (постоянная тональность) 660 Гц (с прерыванием) 800 / 1000 Гц (меняющаяся тональность) 544 / 440 Гц (NF S 32-001)
	Область использования сигнализации	EN54-3: см. документ 30304-005-1
	Класс защиты окружающей среды	Б
	Испытания проводились с использованием мембранного ниппеля (в комплекте) и внешних крепежных отверстий.	
Союз страховщиков	<b>G 212115</b> , см. Директиву ЕС по строительным изделиям (305/2011/EC)	
GL	<b>61062-13 HH</b> Класс безопасности по отношению к окружающей среде C, H, EMC1	
MED	<b>61739-14 HH</b>	
CNBOP	РА 5: <b>2015/2014</b>	
UL, cUL	UCST, UCST7, ULSZ, ULSZ7, UEES, UEES7 (Дополнительную информацию см. на стр. 7)	

## Ввод в эксплуатацию

### Указания по технике безопасности:

- Подключение электрооборудования разрешается выполнять только уполномоченным сотрудникам в соответствии с предписаниями действующего законодательства.
- Осторожно: высокое напряжение.
- Во время монтажных работ питание должно быть отключено от устройства.
- Перед вводом в эксплуатацию следует проверить соответствие напряжения данным, указанным на заводской табличке. При подключении неверного напряжения оборудование может быть повреждено или выведено из строя.
- Во время монтажа необходимо предусмотреть меры, чтобы проводка не могла быть вытянута или перекручена. Следует принять во внимание, что данные устройства не являются переносными.
- **ВНИМАНИЕ!** При монтаже проводка не должна касаться острых краёв, углов и внутренних компонентов.
- Отверстие рупора не должно быть направлено вверх, особенно при использовании вне помещения или в запылённой среде.
- Надлежащее функционирование устройства гарантируется только в том случае, если верхняя и нижняя части смонтированы правильно.

Комбинированные светозвуковые устройства (РА X 5-05/ РА X 5-10):

- Чтобы исключить отрицательное влияние на зрение, не рекомендуется долго смотреть на включенную проблесковую лампу.

### Открытие корпуса:



### Закрывание корпуса

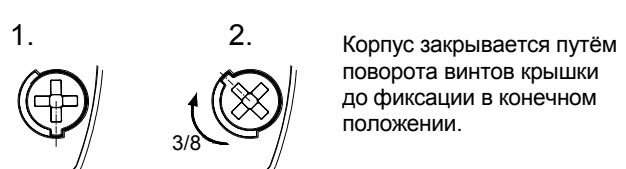

Устройство поставляется в открытом виде.

В качестве аксессуаров предлагаются пломбировочные пробки.

### Кабельный ввод

Для сохранения имеющегося класса защиты в предусмотренные отверстия должны быть установлены кабельные вводы класса IP 66. Поставляемый мембранный ниппель можно заменить резьбовой втулкой или штекерным соединением M12 с фланцем M20.

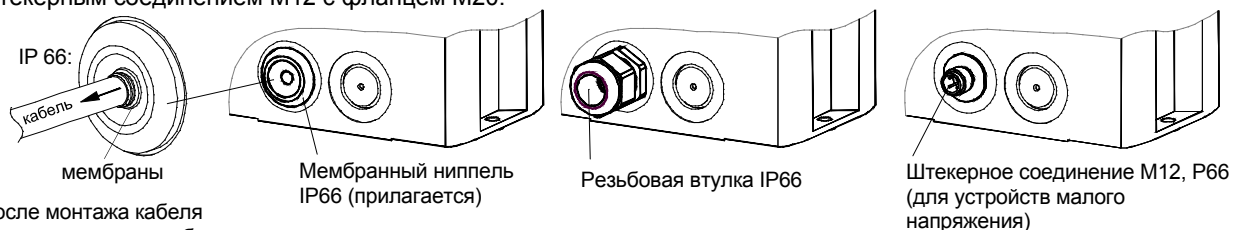

После монтажа кабеля удалить остатки мембраны.

**Клеммная колодка в нижней части:  
Подключение питания и выбор тональности посредством внешней настройки (C1 и C2)**

Подключение рабочего напряжения для звуковой сигнализации:

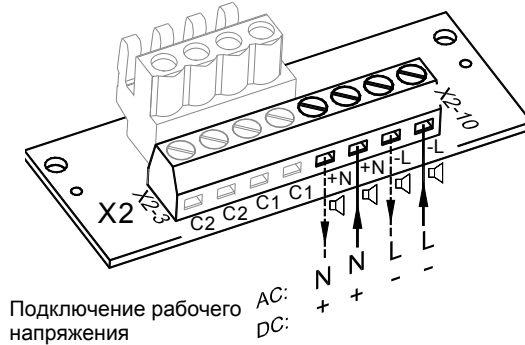

Подключение рабочего напряжения для звукового и светового оповещения:

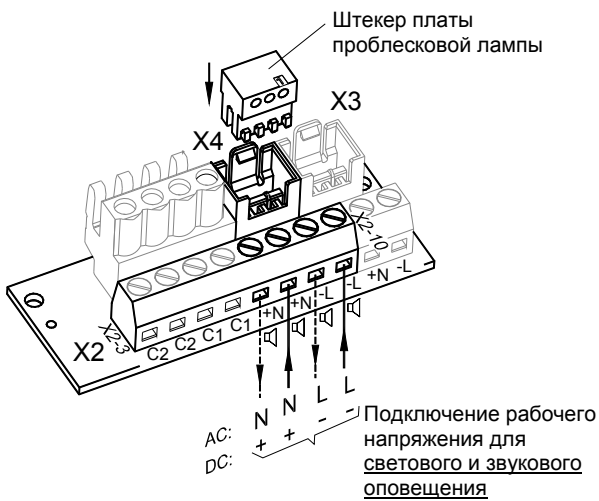

Общее подключение звукового и светового оповещения (вид поставляемого изделия)

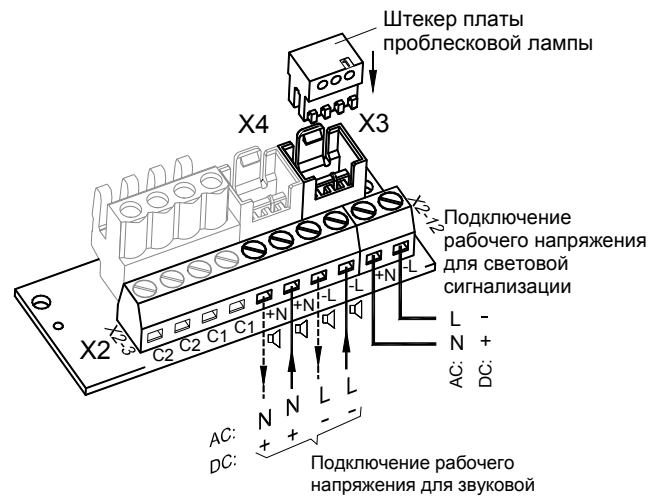

Раздельное подключение звукового и светового оповещения

Тональность можно выбрать с помощью переключателя S3 (задающая сигнал плата в верхней части). Описание возможных тональностей см. в таблице в приложении. После подключения питания активируется звук выбранной тональности.

**Клеммная колодка (в верхней части устройства):**

**Постоянный ток**

S1B S1A

S3

S1B выбор полярности управляющего напряжения для C1 и C2

S1A шунтирование защиты от неправильного подключения полюсов

**Переменный ток**

S3

Информация относительно звуковой сигнализации: для соответствия нормам EN 54-3 должна быть выбрана максимальная громкость.

Переключатель тональности

<p>S1B S1A</p> <p>+        </p> <p>-        </p>	<p>Диод не шунтирован</p> <p>Полярность: -</p> <p><b>заводская настройка</b></p>
<p>S1B S1A</p> <p>+        </p> <p>-        </p>	<p>Диод не шунтирован</p> <p>полярность: +</p>
<p>S1B S1A</p> <p>+        </p> <p>-        </p>	<p>Диод шунтирован</p> <p>Полярность: -</p>
<p>S1B S1A</p> <p>+        </p> <p>-        </p>	<p>Диод шунтирован</p> <p>Полярность: +</p>

## Изменение тональности посредством внешней настройки

Для случаев, когда требуется более одной звуковой тональности, посредством электрической настройки можно выбрать до трёх дополнительных тонов.

Прежде всего, устанавливается основная тональность (♯, см. таблицу в приложении) с помощью переключателя S2 или S3 на задающей сигнал плате. Дополнительную тональность (C1, C2, C1+C2) см. в таблице «Выбор тональности» в приложении.

### Выбор тональности через вход управления (TAS)

#### Версия, работающая от постоянного тока:

При правильном подключении полюсов выбор тональности осуществляется через входы C1 и C2 клеммной колодки. При этом должны быть подключены как входы управления, так и напряжение питания.

Положение переключателя S1A:  $\nabla$ .

С помощью переключателя S1B на задающей сигнал пластине осуществляется выбор управляющего напряжения («+» или «-»).

«+»: положительная настройка

«-»: отрицательная настройка (заводская)

**Внимание:** Если управляющее напряжение превосходит напряжение питания или напряжение питания отсутствует, ток питания подаётся через входы управления. При этом нагрузка не должна превышать допустимую.

#### Версия, работающая от переменного тока:

В версии, работающей от переменного тока, выбор тональности осуществляется посредством подключения фазы «L» напряжения питания к входу управления C1 или C2. При этом должны быть подключены как вход управления, так и линия питания.

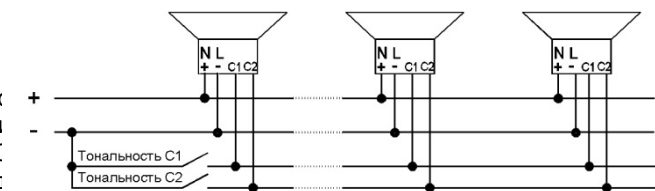
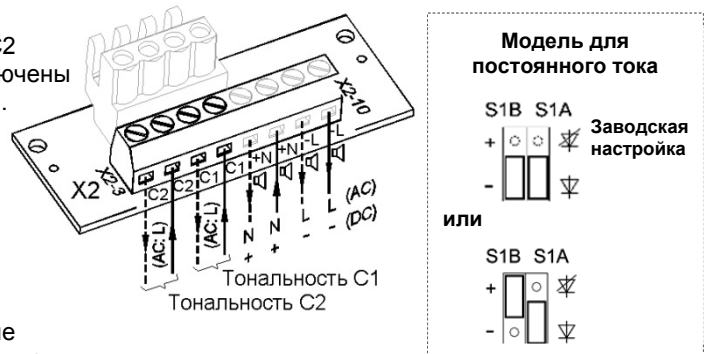

Пример для настройки «-»

### Выбор тональности путём подключения питания к входу управления TAV – для всех версий постоянного тока

Рабочее напряжение можно подключить к звуковой сигнализации через входы управления C1 или C2 на клеммной колодке. В этом случае входы служат как для выбора тональности, так и подачи питания.

Отрицательный полюс звуковой сигнализации должен быть подключен. Основная тональность устанавливается путём подключения положительного контакта к положительному полюсу присоединительной планки (♯); при подключении входов C1 и C2 настраивается соответствующая тональность.

При одновременном подключении положительного контакта к C1 и C2 выбирается тональность «C1+C2».

Переключатель S1B на задающей сигнал пластине должен находиться в положении «+».

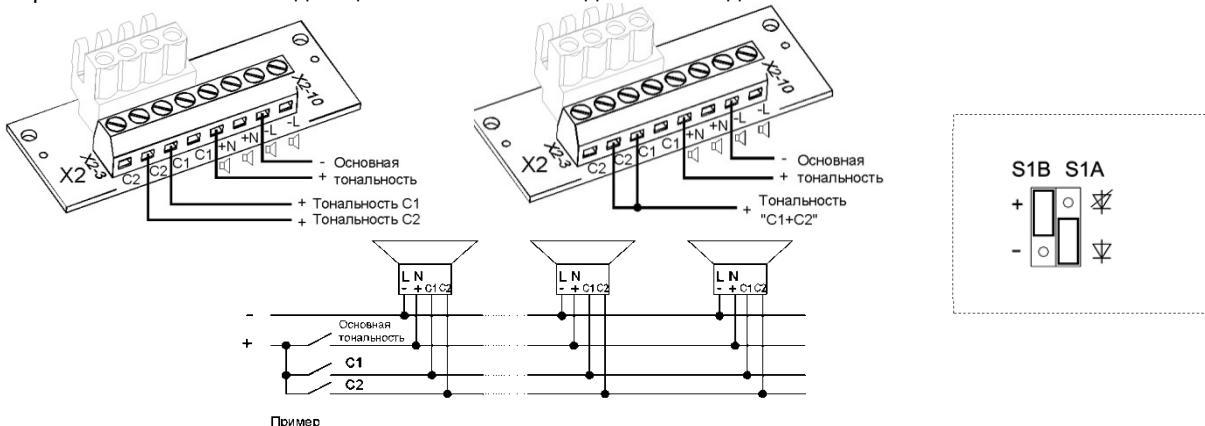

Пример

### Выбор тональности путём изменения полярности TAR – для всех версий постоянного тока (кроме опции SSM)

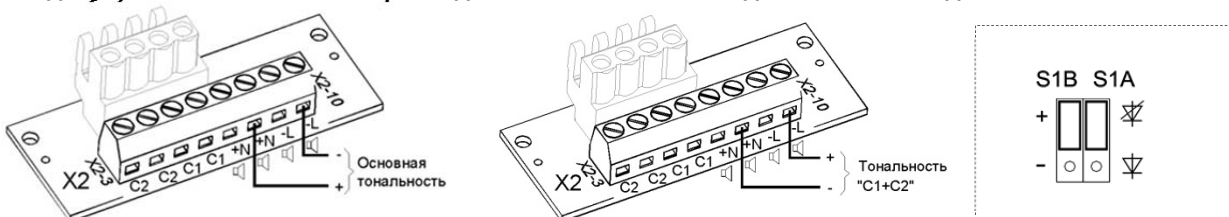

Если переключатель S1A на задающей пластине включен, путём изменения полярности рабочего напряжения помимо основной тональности (♯) можно выбрать тональность «C1+C2». Переключатель S1B должен быть в положении «+».

Входы управления C1 и C2 на присоединительной планке не должны быть подключены.



## Опция SSM (Модуль плавного пуска) (только 24 В пост. тока):

- Максимальный пусковой ток:

PA 5-SSM:	 : макс. 2,1 А	
PA X 5-xx-SSM:	 : макс. 2,1 А	 : макс. 4,5 А

- К устройству подводится напряжение питания, превышающее 7 В

- Резистор контроля кабеля

Диапазон рабочего напряжения: 18 – 30 В пост.тока

## Резистор контроля кабеля:

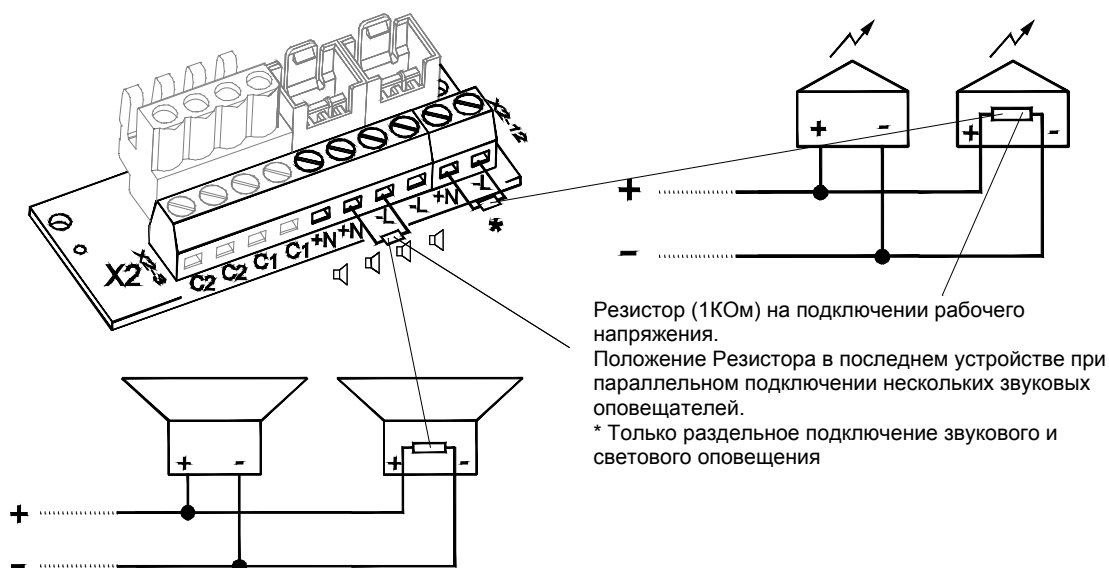

## Техническое обслуживание и поддержание в исправном состоянии

Для данного устройства специальное техническое обслуживание не требуется. Очистка наружных поверхностей осуществляется с помощью слабого мыльного раствора без использования растворителей.

Разрешается использовать *устройство* только в неповреждённом состоянии, согласно техническим характеристикам. При изменении конструкции, модификации оборудования, его неправильном использовании и использовании не по назначению, а также при несоблюдении указаний данного руководства гарантия теряет свою силу.

Разрешается использовать только оригинальные запасные части. Ремонт производится только на предприятии-изготовителе.

# PA 5 / PA X 5-05/ PA X 5-10 - Manuale d'uso e installazione

## Dimensioni

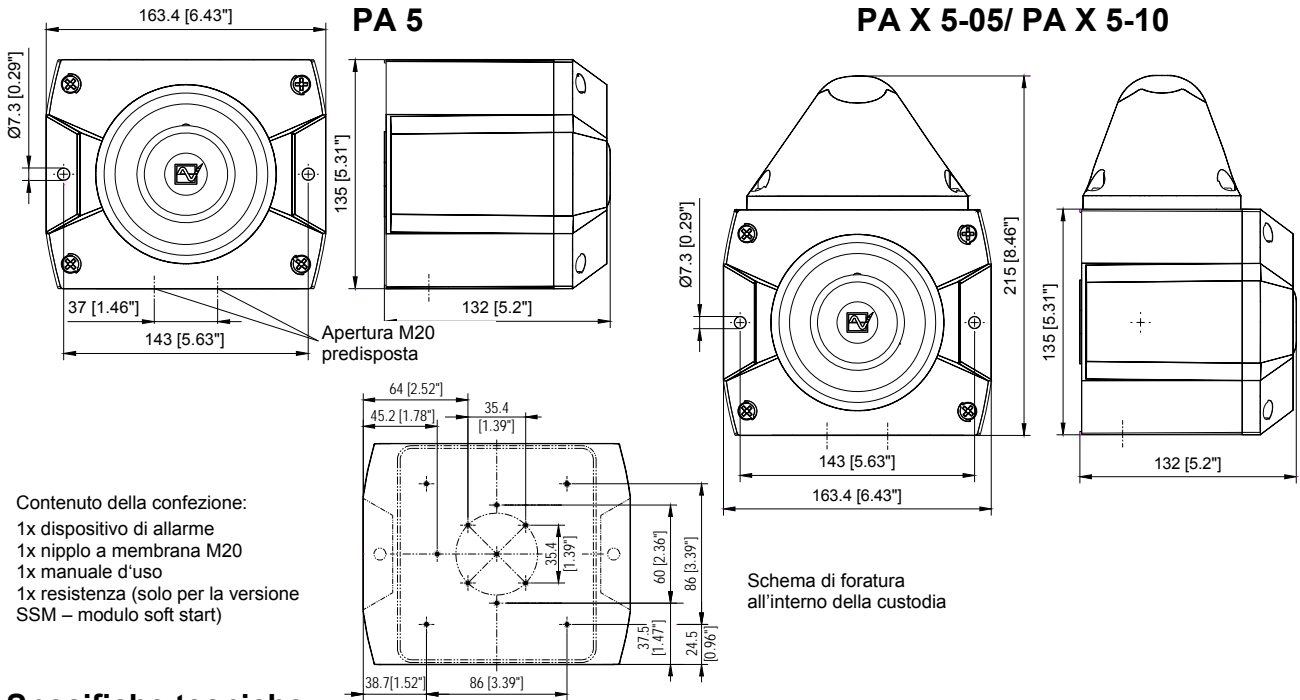

## Specifiche tecniche

	PA 5				PA X 5-05/ PA X 5-10					
Intensità sonora nom.	105dB (A) 1m									
Regolazione volume	max. -12dB									
Suoni	80									
Energia flash	-				PA X 5-05: 5J			/ PA X 5-10: 10J		
Frequenza di sequenza flash	-				1Hz					
Tensione nominale (per le limitazioni consultare le omologazioni)	24V CC oppure 12 – 48 V CC	24V CA 50/60 Hz	115V CA 50/60 Hz	230V CA 50/60 Hz	12V CC	24V CC	48V CC	24V CA 50/60 Hz	115V CA 50/60 Hz	230V CA 50/60 Hz
Intervallo di tensione	10 - 57 V CC	18-30 V CA	95 – 127 V CA	195 – 253 V CA	10-15 V CC	18-30 V CC	40-57 V CC	18-30 V CA	95 – 127 V CA	195 – 253 V CA
Corrente assorbita segnalatore acustico (max)	80 mA	150 mA	30 mA	16 mA	25 mA	70 mA	80 mA	150 mA	30 mA	16 mA
Corrente assorbita luce flash (max)	-	-	-	-	5 J: 700 mA 10 J: 1400 mA	5J: 360 mA 10 J: 680 mA	5 J: 170 mA 10 J: 300 mA	5 J: 800 mA 10 J: 1400 mA	5 J: 120 mA 10 J: 300 mA	5 J: 90 mA 10 J: 160 mA
Potenza assorbita	12-48CC:4W 24 CC: 2W	4,5 VA	4,5 VA	4,5 VA	8 W	11,5 W	11,5 W	34,5 VA	18,5 VA	25 VA
Fattore di servizio	100%									
Morsetti	0,14 - 2,5mm <sup>2</sup> cavo flessibile / AWG24 - AWG 14 (trefolo)									
Grado di protezione	IP66 (EN60529), Tipo 4 & 4x									
Resistenza agli urti	IK08 (EN50102)									
Classe di protezione	II									
Temperatura d'esercizio	-40°C...+55°C									
Temperatura di stoccaggio	-40°C...+70°C									
Max. umidità relativa dell'aria	90%									
Ingresso cavi	6x M20 predisposti				4x M20 predisposti					
Intervallo di serraggio passacavo	7 – 13 mm In caso di utilizzo di cavi di diametro < 7 mm bisogna prevedere un raccordo pressacavo con un grado di protezione adeguato									
Materiale custodia	Miscela PC/ABS									
Materiale calotta	PC									
Materiale custodia	A piacere									
Opzioni	-SSM (vedere pagina 26)									
Accessori	Tappi sigillanti (n° art. 28300000002)									
Colori calotta	Trasparente neutro, bianco, giallo, arancione, rosso, verde, blu									

## Omologazioni

Omologazioni (solo per dispositivi con marcatura)																	
Regolamento sui prodotti da costruzione (305/2011/CEE)  	<b>VdS 0786-CPD-21182</b>  <table border="1"> <thead> <tr> <th colspan="2">PA 5</th> </tr> </thead> <tbody> <tr> <td>Opzioni</td> <td>-SSM (24V CC)</td> </tr> <tr> <td>Tensione nominale</td> <td>24 – 48 V CC</td> </tr> <tr> <td>Intervallo di tensione secondo EN54-3</td> <td>18V – 57V Option: -SSM (18V – 30V)</td> </tr> <tr> <td>Suono</td> <td>In conformità con la Direttiva sui prodotti da costruzione (89/106/CEE) 1200Hz-500Hz (dente di sega) DIN/PFEER P.T.A.P. 500Hz-1200Hz (suono ascendente) 825Hz (suono continuo) 660Hz (suono intermittente) 800Hz/ 1000Hz (suono alternato) 544Hz/ 440Hz (NF S 32-001)</td> </tr> <tr> <td>Volume di copertura</td> <td>EN54-3: vedere documento 30304-005-1</td> </tr> <tr> <td>Classe di protezione ambientale</td> <td>Tipo B</td> </tr> <tr> <td colspan="2">La verifica è stata effettuata utilizzando il nipplo a membrana fornito e i fori di fissaggio esterni.</td> </tr> </tbody> </table>	PA 5		Opzioni	-SSM (24V CC)	Tensione nominale	24 – 48 V CC	Intervallo di tensione secondo EN54-3	18V – 57V Option: -SSM (18V – 30V)	Suono	In conformità con la Direttiva sui prodotti da costruzione (89/106/CEE) 1200Hz-500Hz (dente di sega) DIN/PFEER P.T.A.P. 500Hz-1200Hz (suono ascendente) 825Hz (suono continuo) 660Hz (suono intermittente) 800Hz/ 1000Hz (suono alternato) 544Hz/ 440Hz (NF S 32-001)	Volume di copertura	EN54-3: vedere documento 30304-005-1	Classe di protezione ambientale	Tipo B	La verifica è stata effettuata utilizzando il nipplo a membrana fornito e i fori di fissaggio esterni.	
	PA 5																
	Opzioni	-SSM (24V CC)															
	Tensione nominale	24 – 48 V CC															
	Intervallo di tensione secondo EN54-3	18V – 57V Option: -SSM (18V – 30V)															
	Suono	In conformità con la Direttiva sui prodotti da costruzione (89/106/CEE) 1200Hz-500Hz (dente di sega) DIN/PFEER P.T.A.P. 500Hz-1200Hz (suono ascendente) 825Hz (suono continuo) 660Hz (suono intermittente) 800Hz/ 1000Hz (suono alternato) 544Hz/ 440Hz (NF S 32-001)															
	Volume di copertura	EN54-3: vedere documento 30304-005-1															
	Classe di protezione ambientale	Tipo B															
La verifica è stata effettuata utilizzando il nipplo a membrana fornito e i fori di fissaggio esterni.																	
VdS	<b>G 212115</b> Per i dati vedere il regolamento sui prodotti da costruzione (305/2011/CEE)																
GL	<b>61062-13 HH</b> Categoria ambientale C, H, EMC1																
MED	<b>61739-14 HH</b>																
CNBOP	PA 5: <b>2015/2014</b>																
UL, cUL	UCST, UCST7, ULSZ, ULSZ7, UEES, UEES7 (ulteriori informazioni a pagina 7)																

## Messa in funzione

### Precauzioni da adottare:

- Il collegamento elettrico deve essere realizzato esclusivamente per opera di personale autorizzato e in conformità alle prescrizioni attualmente in vigore.
- Pericolo: presenza di alta tensione.
- Prima dell'apertura accertarsi che l'apparecchio non sia sotto tensione.
- Prima della messa in funzione verificare la tensione di alimentazione riportata sulla targhetta identificativa. Una tensione d'esercizio errata può provocare danni al dispositivo o la distruzione dello stesso.
- In fase di installazione controllare il cavo di collegamento al fine di prevenirne la trazione e la torsione. Attenzione: questi segnalatori non sono progettati per un uso mobile.
- **AVVERTENZA:** in fase di installazione mantenere la cavetteria a distanza da componenti interni, angoli e spigoli vivi.
- L'apertura della tromba acustica non deve essere rivolta verso l'alto, in particolare in caso di impiego all'esterno oppure in ambienti con forte presenza di polvere.
- Il funzionamento dell'apparecchio è garantito solo se la sezione superiore e la sezione inferiore sono collegate correttamente.

In caso di utilizzo della combinazione con la luce PA X 5-05/ PA X 5-10:

- Per prevenire danni alla vista, non fissare la luce accesa.

### Apertura della custodia:

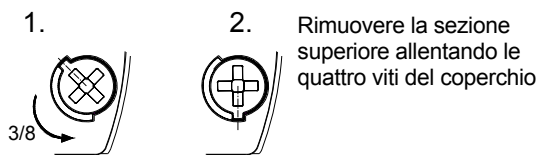

### Chiusura della custodia:

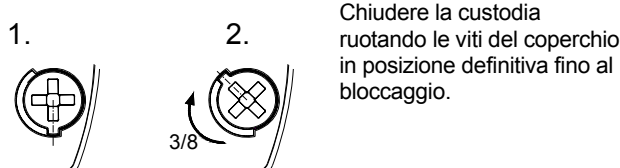

L'apparecchio viene fornito non chiuso.

Come accessori sono disponibili tappi sigillanti per le viti della custodia.

### Passaggi per cavi

Per garantire il grado di protezione indicato occorre montare passaggi per cavi con un grado di protezione IP 66 nelle aperture appositamente previste. Il nipplo a membrana fornito può essere sostituito da un raccordo pressacavo o da un connettore M12 con flangia M20.

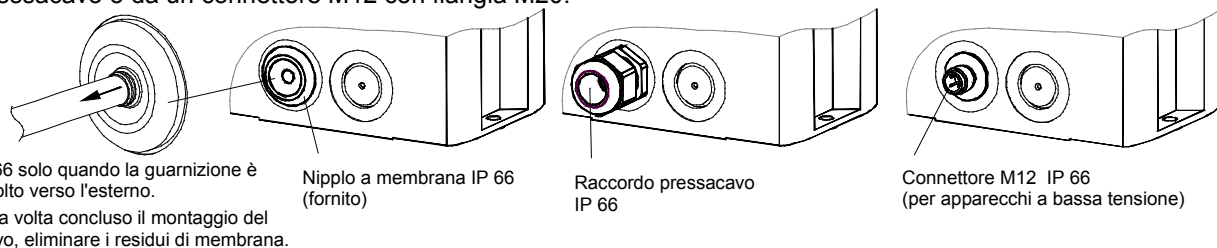

**Scheda di collegamento nella sezione inferiore:**  
**Collegamento elettrico e selezione dei suoni tramite dispositivo di comando esterno C1 e C2**

Collegamento della tensione d'esercizio – Segnalatore acustico

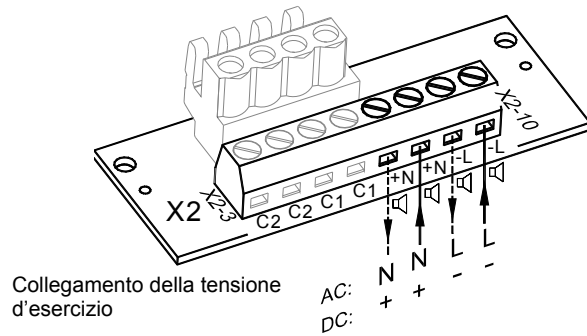

Collegamento della tensione d'esercizio – Combinazione segnalatore acustico – luci flash:

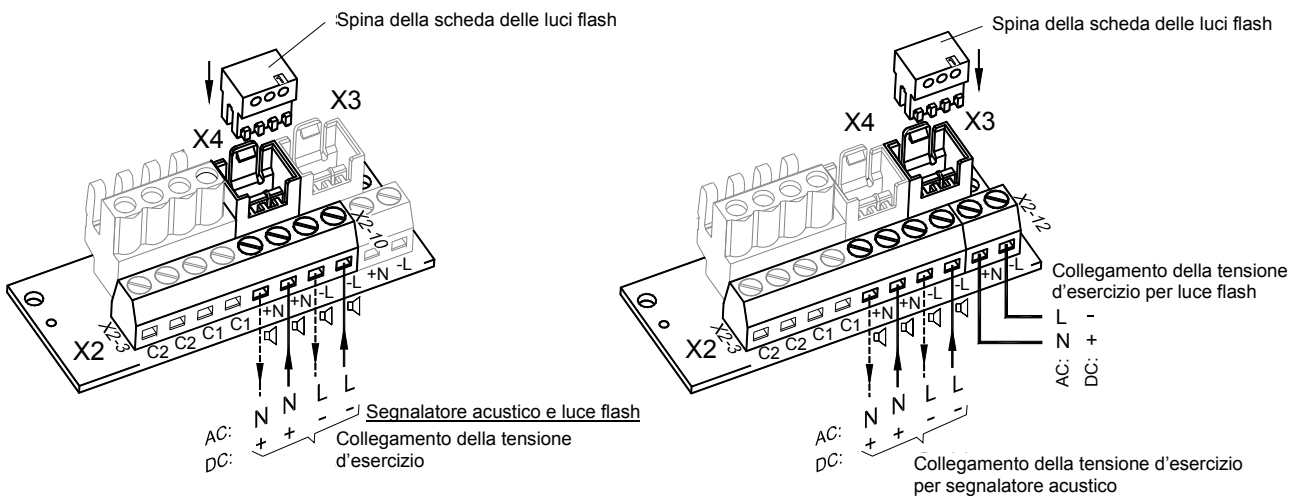

**Collegamento comune di luce flash e segnalatore acustico (stato alla consegna)**

**Collegamento separato di luce flash e segnalatore acustico**

Il suono desiderato è selezionabile grazie al selettore S3 (sulla scheda driver nella sezione superiore). I suoni disponibili sono descritti nella relativa tabella in appendice. Applicare la tensione di alimentazione per generare il suono.

**Scheda driver del segnalatore acustico (nella sezione superiore):**

**Versione CC**

**Versione CA**

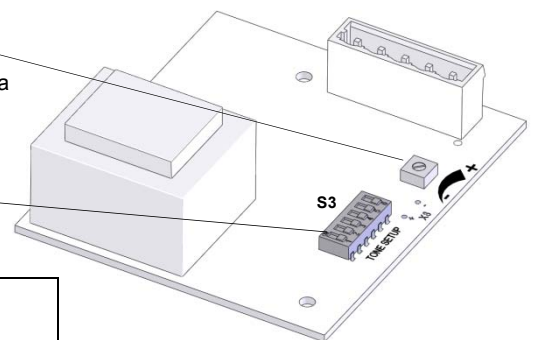
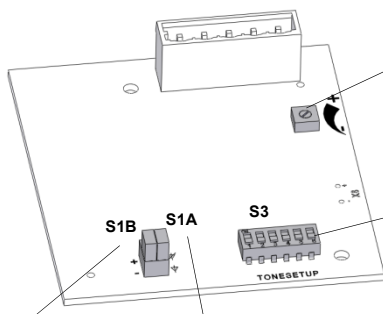

Controllo volume  
 Avvertenza:  
 Per essere conforme alla norma EN54-3, il controllo del volume deve trovarsi nella posizione massima.

Selettore di suoni

**S1B**  
 Scelta della polarità della tensione di comando per C1 e C2

**S1A**  
 Esclusione (*override*) del diodo inversione di polarità

S1B S1A + □ □ ▯ - □ □ ▯	Diode senza ponte Polarità: negativa <b>Impostazione di fabbrica</b>
S1B S1A + □ □ ▯ - □ □ ▯	Diode senza ponte Polarità: positiva
S1B S1A + □ □ ▯ - □ □ ▯	Ponte a diode Polarità: negativa
S1B S1A + □ □ ▯ - □ □ ▯	Ponte a diode Polarità: positiva



## Modifica dei suoni tramite dispositivo di comando esterno

Per applicazioni che richiedono più suoni, i dispositivi di comando elettrici descritti di seguito consentono di aggiungerne fino ad altri tre, oltre a quello di base.

In linea di massima, il selettore S3 nella scheda driver consente di impostare solo il suono base desiderato (♫, vedere relativa tabella in appendice). I corrispondenti suoni supplementari (C1, C2, C1+C2) sono desumibili dalla tabella "Comando suoni" in appendice.

### Scelta del livello dei suoni mediante ingresso di controllo (TAS)

#### Versione CC:

Quando la polarità è corretta, la selezione del suono avviene tramite gli ingressi di controllo C1 e C2 nella scheda di collegamento. La tensione di alimentazione deve sempre essere applicata insieme ai due ingressi di controllo. Collegamento S1A sulla scheda (Diode non ponteggiato):  $\nabla$ .

La polarità della tensione di comando viene scelta („+“ tramite il selettore S1B sulla scheda driver („+“ o „-“).

„+“: comando positivo

„-“: comando negativo (impostazione di fabbrica)

**Attenzione:** Se la tensione di comando è maggiore della tensione di alimentazione o non viene applicata tensione di alimentazione, la corrente d'esercizio viene alimentata tramite gli ingressi di controllo. Occorre quindi garantire una portata adeguata.

#### Versione CA:

Nella versione CA, il suono viene scelto collegando la fase "L" della tensione di alimentazione agli ingressi di controllo C1 o C2. La tensione di alimentazione deve sempre essere applicata insieme ai due ingressi di controllo (qui a sx esempio per un comando "-").

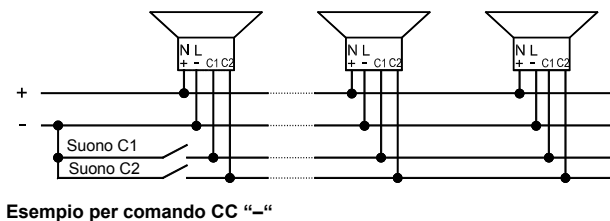
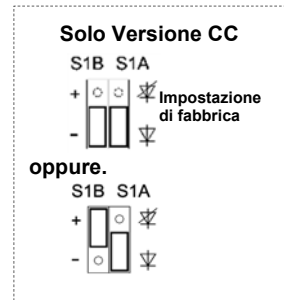
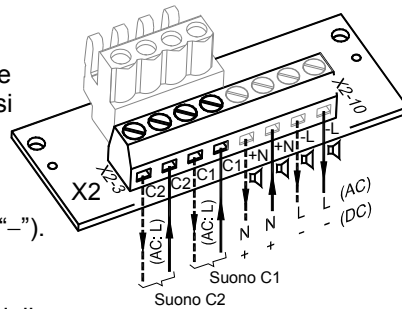

### Scelta del livello dei suoni mediante alimentazione tramite ingresso di controllo (TAV) – per tutte le versioni CC

Il segnalatore acustico può essere alimentato con tensione d'esercizio tramite gli ingressi di controllo C1 e C2 sulla scheda di collegamento. Alimentazione e scelta del livello dei suoni avvengono quindi contemporaneamente. Il polo negativo del segnalatore acustico deve essere collegato. Il collegamento della tensione positiva al polo positivo della scheda di collegamento genera il suono base (♫); il collegamento agli ingressi C1 e C2 consente di scegliere i corrispondenti livelli dei suoni.

Il collegamento simultaneo della tensione positiva agli ingressi C1 e C2 consente di scegliere il livello "C1+C2". Il selettore S1B sulla scheda driver deve essere su "+".

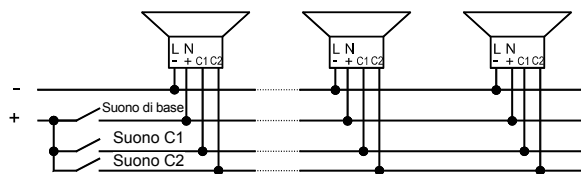
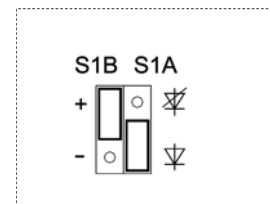
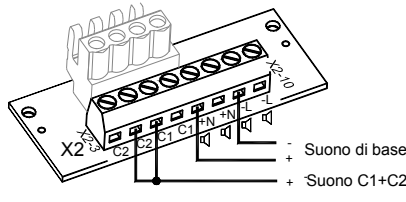
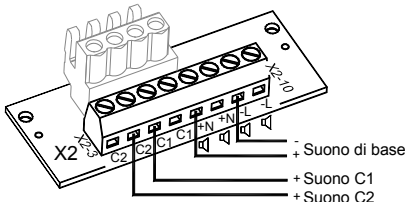

Esempio di collegamento

### Scelta del livello dei suoni tramite inversione di polarità (TAR) - per tutte le versioni CC (tranne l'opzione SSM)

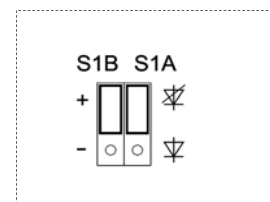
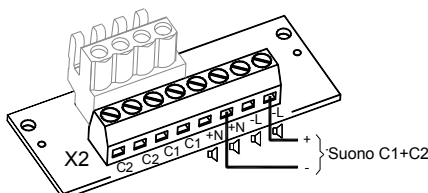
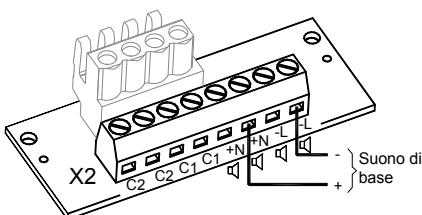

Al collegamento S1A  $\nabla$  della scheda, può essere selezionata la polarità dell'alimentazione al suono base (♫) in aggiunta al suono "C1+C2". Il selettore S1B deve essere impostato su "+".

**Gli ingressi di controllo C1 e C2 non devono essere cablati sulla scheda di collegamento.**



## Opzione SSM (modulo *soft start*, solo 24V CC)

- Limitazione della corrente allo spunto a:

<b>PA 5-SSM:</b>	 : max. 2,1 A	
<b>PA X 5-xx-SSM:</b>	 : max. 2,1 A	 : max. 4,5 A

- Commutazione della tensione d'esercizio al dispositivo solo a partire da > 7V
- Resistenza per il monitoraggio cavi collegata

Intervallo della tensione d'esercizio: 18V – 30V CC

### Resistenza per il monitoraggio cavi:

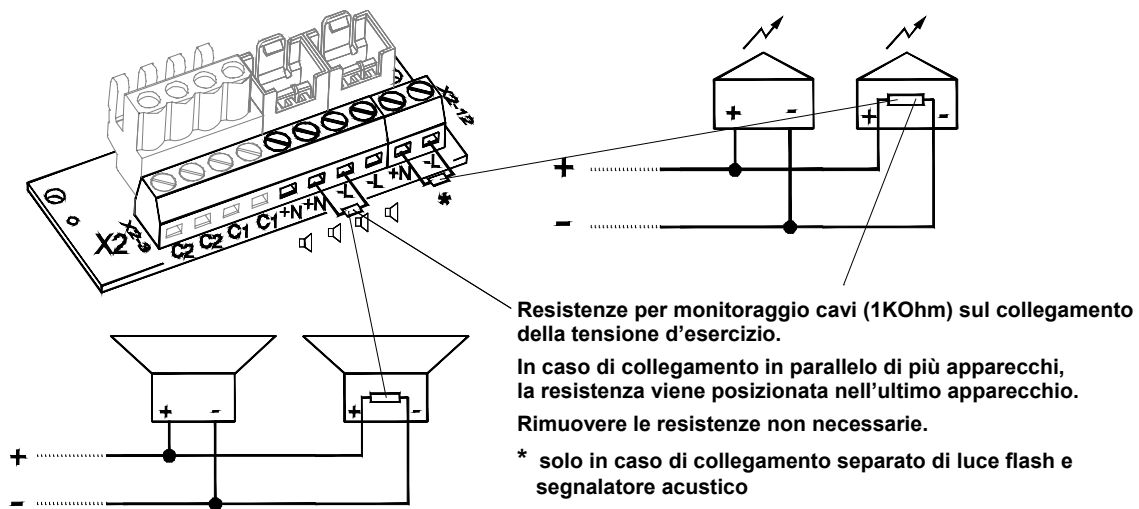

## Manutenzione, assistenza, riparazione

























L'apparecchio non necessita di una particolare manutenzione. Per la pulizia esterna utilizzare un detergente neutro senza solventi.





















Il segnalatore acustico può essere utilizzato solo se perfettamente integro e nel rispetto dei dati tecnici specificati. Eventuali modifiche e alterazioni così come l'impiego errato o non consentito e il mancato rispetto delle istruzioni riportate nel presente manuale comportano l'esclusione della garanzia.

Per eventuali sostituzioni di componenti utilizzare solo pezzi di ricambio originali. Gli interventi di riparazione vengono effettuati in linea di massima presso l'officina del costruttore.

**Anhang/ Appendix/ Annexe/ Appendice**  
**„Tonartentabelle“ und „Ansteuerung der Töne“**  
**„Tone table“ and „Selection of the tones“**  
**«Tableau des sons» et «Activation des sons»**

**Tonartentabelle/ Tone table/ Tableau de sons/ Tabella suoni**

Grund-Ton-Nr. (♫)	Beschreibung/ Description/ Descrizione		
1	Kein Ton/ Silence		
2*	Saw tooth, Germany DIN 33404-3 (emergency signal), PFEER PTAP	1200Hz 500Hz	 EN54-3
9	Slow whoop, fire alarm, UK BS5839-1	970Hz 800Hz	
11	Whoop (fast)	970Hz 800Hz	
13	Whoop	900Hz 700Hz	
15	Slow whoop, evacuation, Netherlands NEN 2575	1200Hz 500Hz	 EN54-3
16	Slow whoop, evacuation Australia AS2220	1200Hz 500Hz	
18	Slow whoop, NFPA	775Hz 422Hz	
22	Whoop, Australia AS1670, ISO8201	1200Hz 500Hz	
23	Siren	2400Hz 500Hz	
24	Siren	1200Hz 300Hz	
25	Siren	800Hz 300Hz	
26	Industrial alarm (Germany)	1000Hz 150Hz	
27	Sweeping	2900Hz 2400Hz	
29	Sweeping (fast)	2900Hz 2400Hz	
30	Sweeping	2900Hz 2400Hz	
31	Sweeping, France NF C 48-265	1600Hz 1400Hz	
33	Sweeping, UK BS5839-1 (medium sweep)	1000Hz 800Hz	
34	Sweeping (fast)	1000Hz 800Hz	
35	Sweeping, UK BS5839-1 (fast sweep)	1000Hz 800Hz	
36	Sweeping	1500Hz 700Hz	
43	Sweeping	1200Hz 500Hz	
44	Sweeping, IMO 3d, Germany KTA3901 evacuation	1200Hz 500Hz	
45	Sweeping	1200Hz 500Hz	
46	Sweeping, Finland General Alarm	1500Hz 500Hz	
52	Continuous	2400Hz	— —
53	Continuous	2000Hz	— —

(♫)	Beschreibung/ Description/ Descrizione	
54	Continuous, Finland All Clear	1500Hz — —
55	Continuous	1200Hz — —
56	Continuous, PFEER (Gasalarm)	1000Hz — —
57	Continuous, UK BS5839-1	950Hz — —
59	Continuous	880Hz — —
60	Continuous	825Hz — — EN54-3
61	Continuous	800Hz — —
63	Continuous	725Hz — —
65	Continuous, Sweden SS031711 (All Clear)	660Hz — —
66	Continuous	554Hz — —
67	Continuous, Germany KTA3901 (All Clear)	500Hz — —
68	Continuous	470Hz — —
69	Continuous	440Hz — —
71	Continuous	340Hz — —
77	Intermittent	2400Hz 
82	Intermittent, PFEER (General Alarm), UK BS5839-1 (Backup Alarm)	1000Hz 
83	Intermittent, PFEER (General Alarm)	1000Hz 
88	Intermittent	950Hz 
90	Intermittent	825Hz 
91	Intermittent	800Hz 
92	Intermittent	800Hz 
93	Intermittent (fast), electromechanical horn	800Hz 
97	Intermittent	725Hz 
98	Intermittent, Sweden SS 031711 (Imminent Danger)	700Hz 
100	Intermittent, Industrial Alarm (Germany)	680Hz 
101	Intermittent, Sweden SS031711 (Important Message (Pre Mess))	660Hz 
102	Intermittent, Sweden SS031711 (Local Warning)	660Hz 
103	Intermittent, Sweden SS031711 (Air Raid)	660Hz 
104	Intermittent, Sweden SS031711 (Imminent Danger)	660Hz  EN54-3
107	Intermittent, Germany KTA3901 (evacuation)	500Hz 
109	Intermittent, Australia AS2220, AS1610, AS1670	420Hz 
110	Intermittent (fast variable), Bell	1450Hz 
111	Intermittent, ISO8201 (emergency evacuation signal), USA (evacuation)	470Hz 
112	Intermittent, ISO8201 (emergency evacuation signal)	950Hz 
113	Intermittent, ISO8201 (emergency evacuation signal) treble tone	2850Hz 

Grund-Ton-Nr. (J)	Beschreibung/ Description/ Descrizione	
115	Intermittent, IMO (Telephone Call)	950Hz
116	Intermittent, IMO (abandon ship)	950Hz
117	Intermittent, IMO SOLAS III/50 + SOLAS III/6.4 (General Alarm)	825Hz
122	Alternating	2900Hz
123	Alternating	2900Hz
124	Alternating, Singapore	2000Hz
125	Alternating	1400Hz
128	Alternating	1025Hz
130	Alternating, UK BS5839-1 (Fire Alarm)	1000Hz
131	Alternating, UK BS5839-1 (Fire Alarm, Level crossing)	1000Hz
135	Alternating, UK BS5839-1 (Fire Alarm, increased urgency – Level crossing)	1000Hz
142	Alternating	900Hz
143	Alternating, Germany Industrial Alarm	660Hz
144	Alternating	650Hz
146	Alternating, France NFS 32-001 (fire alarm)	554Hz
147	Alternating, Sweden SS031711 (turn out)	554Hz
148	Alternating, Sweden SS031711 (turn out)	554Hz
152	Alternating-intermittent	800Hz

### Ansteuerung der Töne/ Selection of the tones/ Activation des sons/ Comando suoni:

Tonartenschalter/ Selector –switch (Einstellung des Grundtones/ Adjusting the base tone)							External Tone Control		
1	2	3	4	5	6	Grund-Ton No. (J)	Tone No.	Tone No.	Tone No.
						1	2	88	57
ON						2 *	128	112	57
	ON					2	26	100	93
ON	ON					2	61	131	112
		ON				9	57	11	82
ON		ON				15	131	52	112
	ON	ON				16	109	52	56
ON	ON	ON				18	111	57	68
			ON			22	16	109	68
ON			ON			23	131	52	112
	ON		ON			24	131	52	131
ON	ON		ON			25	131	52	92
		ON	ON			26	2	100	93

Tonartenschalter/ Selector –switch (Einstellung des Grundtones/ Adjusting the base tone)							External Tone Control		
1	2	3	4	5	6	Grund-Ton No. (J)	Tone No.	Tone No.	Tone No.
ON		ON	ON			27	123	52	92
	ON	ON	ON			29	35	52	61
ON	ON	ON	ON			30	27	52	77
				ON		31	131	52	57
ON				ON		33	30	52	35
	ON			ON		34	35	52	93
ON	ON			ON		35	27	52	110
		ON		ON		36	146	67	57
ON		ON		ON		43	131	52	91
	ON	ON		ON		45	2	57	93
ON	ON	ON		ON		52	15	65	82
			ON	ON		54	46	54	131
ON			ON	ON		55	131	52	128
	ON		ON	ON		56	82	35	33
ON	ON		ON	ON		59	143	59	101
		ON	ON	ON		60	131	52	125
ON		ON	ON	ON		65	131	52	93
	ON	ON	ON	ON		66	110	52	107
ON	ON	ON	ON	ON		69	131	52	110
				ON		71	131	52	93
ON				ON		77	61	52	122
	ON			ON		82	131	52	83
ON	ON			ON		83	56	2	82
		ON		ON		88	2	57	128
ON		ON		ON		90	131	52	125
	ON	ON		ON		91	30	52	110
ON	ON	ON		ON		92	33	52	57
			ON	ON		93	2	128	57
ON			ON	ON		97	2	63	93
	ON		ON	ON		100	131	52	125
ON	ON		ON	ON		101	98	102	65
		ON	ON	ON		103	131	65	147
ON		ON	ON	ON		104	103	65	101
	ON	ON	ON	ON		109	16	52	22
ON	ON	ON	ON	ON		110	131	61	91
				ON	ON	112	2	57	128
ON				ON	ON	113	52	123	104
	ON			ON	ON	115	117	116	44
ON	ON			ON	ON	116	117	93	125
		ON		ON	ON	117	93	116	125
ON		ON		ON	ON	123	27	52	77
	ON	ON		ON	ON	124	53	83	2
ON	ON	ON		ON	ON	130	2	107	67
			ON	ON	ON	131	2	112	57
ON			ON	ON	ON	135	16	56	109
	ON		ON	ON	ON	142	2	54	88
ON	ON		ON	ON	ON	143	59	93	33
		ON	ON	ON	ON	144	110	61	2
ON		ON	ON	ON	ON	146	31	67	57
	ON	ON	ON	ON	ON	148	131	52	92
ON	ON	ON	ON	ON	ON	152	110	61	13

\* Werkseinstellung/ Factory setting/ Réglage d'usine/  
Заводская настройка/ Impostazione di fabbrica



Pfannenberg GmbH  
Werner-Witt-Straße 1 · D- 21035 Hamburg  
Tel.: +49/ (0)40/ 734 12-0 · Fax: +49/ (0)40/ 734 12-101  
service@pfannenberg.com  
http://www.pfannenberg.com

04/2016