

Ex emergency pull-wire switches

// Ex ZS 75 20/2S / 80-100 N Order no.: 75341307

Features/Options

- Ex zone 1 and 21
- Metal enclosure
- 4 contacts

- Wire length up to 10 m
- Wire pull and breakage detection
- N.B.: Please state required approvals for Russia, China and Brazil with your order!

Dimensions

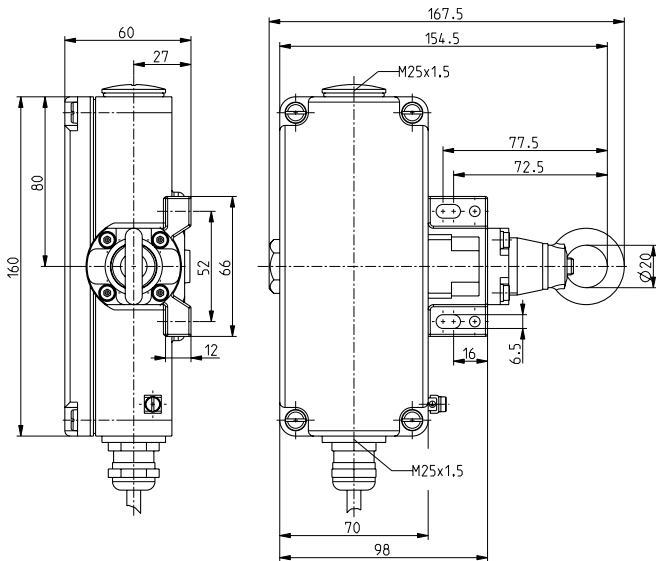

Technical data

Standards

EN 60947-5-1, -5; EN 60079-0,
EN 60079-1, EN 60079-31;
EN ISO 13849-1

Enclosure

aluminium die-cast, enamel finish

Cover

aluminium die-cast, enamel finish

Switch insert

Ex 14

Degree of protection

IP 65 to IEC/EN 60529

Contact material

silver

Switching system

slow action, positive break NC

contacts ⊖

Switching elements

2 NO/2 NC contacts

Connection

cable H05VV-F

B_{10d} (10% Load)

2 million

T_M

max. 20 years

Cable section

4 x 0.75 mm² (incl. conductor
ferrules) per switch insert

Cable section

3 m

U_{imp}

4 kV

U_i

250 V

I_{the}

T6: 6 A, T5: 3 A

Utilisation category

AC-15, DC-13

I_e/U_e

6 A/250 VAC, 0.25 A/230 VDC

Max. fuse rating

6 A gL/gG D-fuse

Ambient temperature

T6: -20 °C ... +65 °C;

T5: -20 °C ... +95 °C

Mechanical life

> 1 million operations

Max. wire length

10 m

Features

wire pull and breakage detection

Ex certification

⊕ II 2G Ex d IIC T6/T5 Gb,

⊕ II 2D Ex tb IIIC

T80°C/T95°C Db IP65

IECEx Ex d IIC T6/T5 Gb,

Ex tb IIIC T80°C/T95°C Db

PTB 11 ATEX 1003 X,

IECEx PTB 07.0034 X

Approvals



Switching diagram

Slow action

2 NC/2 NO contacts

