

Emergency pull-wire switch

// ZS 73 10/1S WVD / 120-180 N Order no.: 73142908

Features/Options

- Metal enclosure
- 2 contacts
- Wire length up to 20 m
- Adjustable actuating force: 120-180 N for 10-20 m

- Release by push button
- Wire pull and breakage function
- Watertight collar W to protect against the entry of foreign bodies

Dimensions

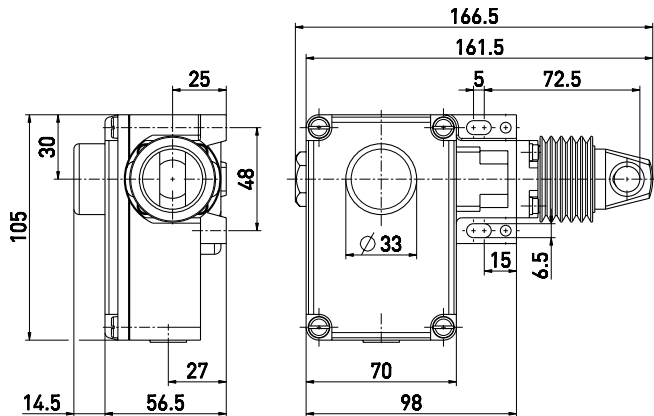

Switching diagram

Snap action

1 NC/1 NO contact

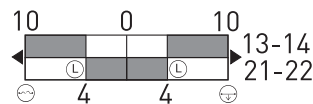

Contact diagram

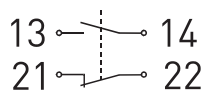

Technical data

Standards

EN ISO 13849-1;
IEC/EN 60947-5-1;
IEC/EN 60947-5-5; EN 418

Enclosure Cover

aluminium die-cast, enamel finish
glass-fibre reinforced,
shock-proof thermoplastic,
ultramid

Degree of protection

IP 65 to IEC/EN 60529

Contact material

silver

Switching elements

change-over contact with double
break

Switching system

snap action, positive break NC

contact ⊖

Connection

screw terminals

Cable section

max. 2.5 mm²
(incl. conductor ferrules)

Cable entry

1 x M16 x 1.5

B_{10d} (10% Load)

200.000

T_M

max. 20 years

U_{imp}

6 kV

U_i

400 V

I_{the}

6 A

Utilisation category

AC-15

I_e/U_e

6 A/400 VAC

Max. fuse rating

6 A gL/gG D-fuse

Ambient temperature

-25 °C ... +70 °C

Mech. life

> 100.000 operations

Max. wire length

20 m

Features

wire pull and breakage function

Approvals



Weight

680g

Errors and omissions excepted.