



Ex Safety sensors

// Ex RC Si 56 20 - 5m Order no.: 25653503

Features/Options

- Ex zone 1 and 21
- Thermoplastic enclosure
- Long life
- Reed contacts, coded

- Actuation from front
- Switching distance up to 7 mm
- N.B.: Please state required approvals for Russia and China with your order!

Note

The actuator is not included with the switches.

Dimensions

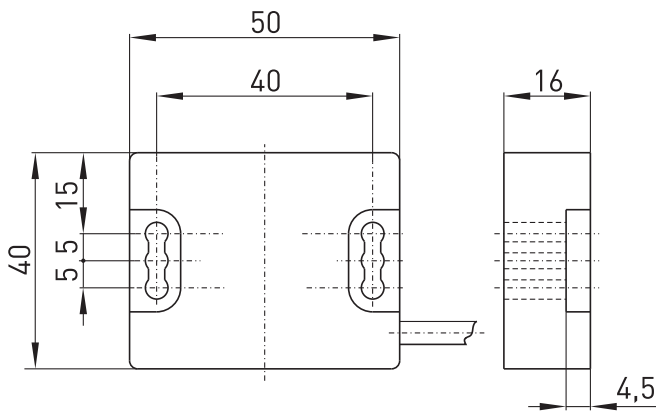

Technical data

Standards

EN ISO 13849-1;
IEC/EN 60947-5-3 / PDF-M*;
EN 954-1; EN 1088;
EN 60079-0; EN 60079-18;
EN 61241-0; EN 61241-1

Enclosure

glass-fibre reinforced
thermoplastic, self-extinguishing,
A3XZG5

Degree of protection

IP 67 according to IEC/EN 60529

Switching system

Reed contacts

Contact types

2 NC contacts

Connection

Pre-wired cable 4 x AWG 24 UL

Cable length

5 m

B_{10d} (10% Load)

1 million

T_M

max. 20 years

$MTTF_d$

>100 years

I_e/U_e

max. 125 mA / 24 VDC

switching voltage

max. 30 VDC

Voltage drop at I_e

2.5 V

Switching frequency

max. 5 Hz

Ambient temperature

T6: -20 °C ... +70 °C;
T5: -20 °C ... +85 °C

Mechanical life

> 10 million operations

Repeatability

< 0.5 mm

Operating distances:

S_{max}

6 mm

S_{ao}

4 mm

S_{ar}

23 mm

Ex marking

Ex II 2G Ex mb II T6/T5,

Ex II 2D Ex tD A21 IP67

T80°C/T95°C

IECEx Ex mb II T6/T5,

Ex tD A21 IP67 T80°C/T95°C

PTB 08 ATEX 2027 X

IECEx PTB 08.0042 X

Approvals



Errors and omissions excepted.

Switching diagram

Reed contacts, coded
2 NC contacts

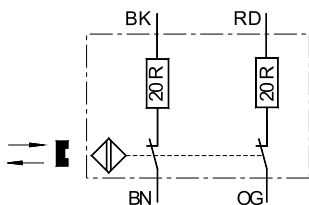

Contact diagram

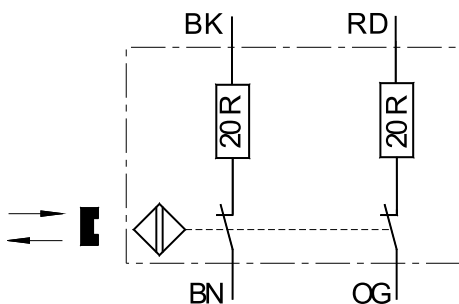



Ex Safety sensors

// Ex RC Si 56 20 - 5m Order no.: 25653503

Axial Misalignment

