

Ex safety switches with separate actuator // Ex AZ 16 1Ö/1S 5m Order no.: 16253303

Features/Options

- Ex zone 1 and 21
- Thermoplastic enclosure
- Multiple coding

- Slow action \ominus , change-over contact with double break
- With prewired cable
- N.B.: Please state required approvals for Russia, China and Brazil with your order!

Dimensions

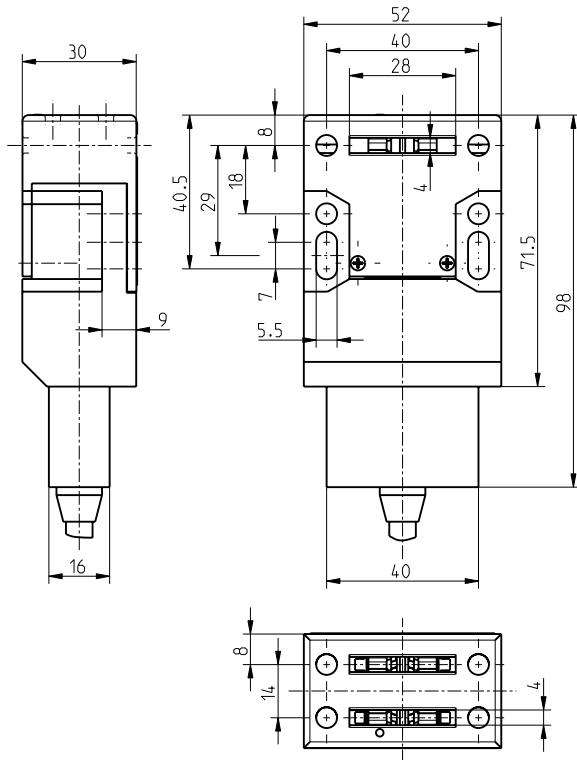

Technical data

Standard	EN 60947-5-1; EN 1088; EN 60079-0, EN 60079-1, EN 60079-31; EN ISO 13849-1
Enclosure	glass-fibre reinforced, shock-proof thermoplastic, self-extinguishing UL 94-V0 stainless steel 1.4301
Actuator	Ex 13
Switch insert	IP 65 according to EN 60529
Degree of protection	silver
Contact material	slow action, positive break NC contact \ominus
Switching system	change-over contact with double break Zb, galvanically separated contact bridges
Switching elements	cable H05VV-F 4 x 0.75 mm ² 2 million max. 20 years
Connection	5m
B_{10d} (10% Load)	4 kV
T_M	250 V
Cable length	T6: 6 A, T5: 3 A
U_{imp}	6 A/250 VAC; 0.25 A/230 VDC
U_i	AC-15, DC-13
I_{the}	6 A gL/gG D-fuse
I_e/U_e	9.5 mm
Utilisation category	ca. 15 N
Max. fuse rating	T6: -20 °C ... +65 °C, T5: -20 °C ... +95 °C
Positive break travel	> 1 million operations
Positive break force	Ex II 2G Ex d IIC T6/T5 Gb, Ex II 2D Ex tb IIIC T80°C/T95°C Db IP65 IECEX Ex d IIC T6/T5 Gb, Ex tb IIIC T80°C/T95°C Db
Ambient temperature	PTB 03 ATEX 1068 X, IECEX PTB 06.0053 X referring to the switch insert
Mechanical life	
Ex certification	
Approvals	



Errors and omissions excepted.