

Magnetic safety sensors

// RC Si 56 2Ö - 5m Order no.: 25650501

Features/Options

- Thermoplastic enclosure
- Long life
- Reed contacts, coded

- Actuation from front
- Switching distance up to 6 mm
- With pre-wired cable

Note: The actuator is not included with the switches.

Dimensions

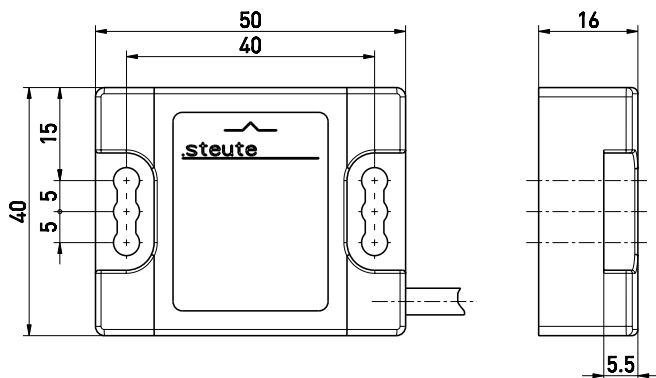

Contact diagram

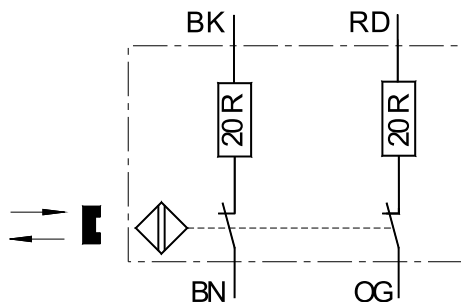

Axial Misalignment

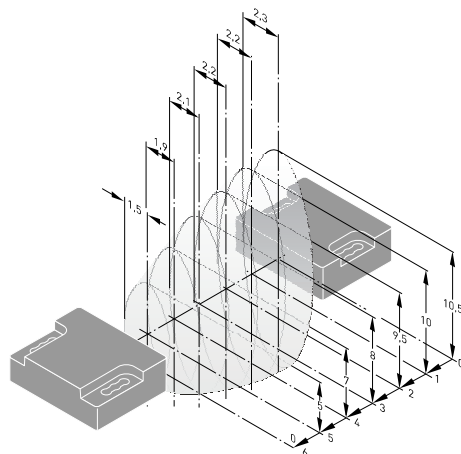

Technical data

Standards

EN ISO 13849-1;
IEC/EN 60947-5-3/PDF-M*;
EN 954-1; EN 1088

Enclosure

glass-fibre reinforced
thermoplastic, self-extinguishing
IP 67 to IEC/EN 60529

Degree of protection

IP 67 to IEC/EN 60529

Switching system

Reed contacts

Contact types

2 NC contacts

Connection

pre-wired cable 4 x AWG 24

Cable length

5 m

B_{10d} (10% Load)

1.000.000

T_M

max. 20 years

$MTTF_d$

> 100 years

U_e

max. 30 VDC

I_e

max. 157 mA DC

Voltage drop at I_{max}

2.5 V

Short-circuit current

max. 750 mA for 50 ms

Switching frequency

max. 5 Hz

Degree of protection

II

Ambient temperature

-20 °C ... +70 °C

Mechanical life

> 10 million operations

Repeatability

< 0.5 mm

Switching capacity

6 mm

S_{max}

4 mm

S_{ao}

23 mm

S_{ar}

* is only achieved in combination
with a safety module

Errors and omissions excepted.